

# USER MANUAL

# ***G-MASTER***

## **LCD Monitor**

ENGLISH

***G-MASTER***  
***GCB3480WQSU***

Thank you very much for choosing the iiyama LCD monitor.

We recommend that you take a few minutes to read this comprehensive manual carefully before installing and switching on the monitor. Please keep this manual in a safe place for your future reference.

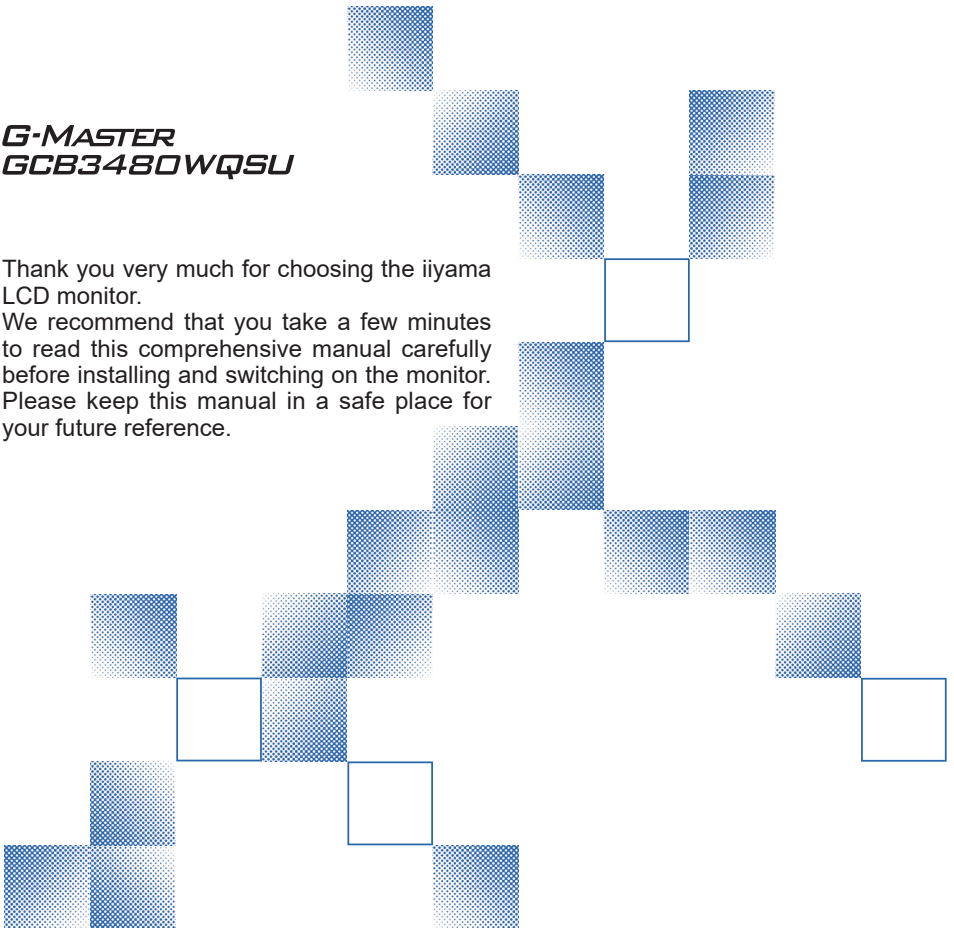



## Dear user, we congratulate you on the purchase of your iiyama LCD.

For details on warranty and locally used pixel policies that apply directly after installation of your product please check the iiyama website.

## To report a fault, please contact your local support centre found at <https://iiyama.com>

### Things to check before you call the iiyama information line

- | if the power cable is connected securely and turned on?
- | if the display has been turned on?
- | if the signal cable is connected securely and the correct input selected?
- | if the computer has been restarted with the display connected?
- | if the graphics card is correctly installed with the latest drivers possible?
- | if the correct native resolution has been selected via 'Display Properties'?
- | If the R/G/B signal configuration is correct?
- | if the displays On Screen Menu is shown?
- | if the correct brightness and contrast settings have been set?
- | if given display tolerances and compatibility have been considered?
- | if via the On Screen Menu you have performed a Factory Reset/Recall?

### Before reporting the screen defect, please prepare the following information/evidence:

- | model number \*
- | purchase receipt and serial number \*
- | name and address for collection
- | telephone/fax number, for availability during the day
- | convenient collection date (date, time)
- | short description of the defect

### Important Note:

If there is no fault found in the collected equipment after inspection, the transferring party shall incur charges for transport and administration.

If you have checked all of the above and there is still no picture, call our information line for assistance in your country.

### Feedback on health and safety issues

If you have any health and safety concerns or questions about the product (including when using the product), please contact iiyama support through our website. You can also contact us by calling +31 204460404. After receiving your feedback, we will ask the responsible unit to handle it as soon as possible and a dedicated person will get back to you. Your feedback will also be recorded and incorporated into our evaluation for improvements

\* see the identification plate on the back of the case.

## CE MARKING DECLARATION OF CONFORMITY

This LCD monitor complies with the requirements of the EC/EU Directive 2014/30/EU "EMC Directive", 2014/35/EU "Low Voltage Directive", 2009/125/EC "ErP Directive" and 2011/65/EU "RoHS Directive".

The electro-magnetic susceptibility has been chosen at a level that gives correct operation in residential areas, business and light industrial premises and small-scale enterprises, inside as well as outside of the buildings. All places of operation are characterised by their connection to the public low voltage power supply system.

IYYAMA CORPORATION: Wijkemeerstraat 8, 2131 HA Hoofddorp, The Netherlands

Model No. : PL3480WQ



We recommend recycling of used product. Please contact your dealer or iiyama service center. Recycle information is obtained via the Internet, using the address: <https://iiyama.com>

You can access the Web page of different countries from there.

- We reserve the right to change specifications without notice.
- All trademarks used in this user manual are the property of their respective owners.
- The terms HDMI and HDMI High-Definition Multimedia Interface, and the HDMI Logo are trademarks or registered trademarks of HDMI Licensing Administrator, Inc. in the United States and other countries.
- Eprel registration number G-MASTER GCB3480WQSU-B1 : 1654168

# TABLE OF CONTENTS

FOR YOUR SAFETY.....	1
SAFETY PRECAUTIONS.....	1
SPECIAL NOTES ON LCD MONITORS.....	3
CUSTOMER SERVICE.....	3
CLEANING.....	3
BEFORE YOU OPERATE THE MONITOR.....	4
FEATURES.....	4
CHECKING THE CONTENTS OF THE PACKAGE.....	4
INSTALLATION.....	5
FITTING AND REMOVAL OF STAND.....	7
CONTROLS AND CONNECTORS.....	9
CONNECTING YOUR MONITOR.....	10
COMPUTER SETTING.....	11
ADJUSTING THE HEIGHT AND THE VIEWING ANGLE.....	11
OPERATING THE MONITOR.....	12
ADJUSTMENT MENU CONTENTS.....	13
STANDBY FEATURE.....	24
TROUBLE SHOOTING.....	25
RECYCLING INFORMATION.....	26
APPENDIX.....	27
SPECIFICATIONS : G-MASTER GCB3480WQSU-B1.....	27
DIMENSIONS.....	28
COMPLIANT TIMING.....	28

# FOR YOUR SAFETY

## SAFETY PRECAUTIONS

### WARNING

#### **STOP OPERATING THE MONITOR WHEN YOU SENSE TROUBLE**

If you notice any abnormal phenomena such as smoke, strange sounds or fumes, unplug the monitor and contact your dealer or iiyama service center immediately. Further use may be dangerous and can cause fire or electric shock.

#### **NEVER REMOVE THE CABINET**

High voltage circuits are inside the monitor. Removing the cabinet may expose you to the danger of fire or electric shock.

#### **DO NOT PUT ANY OBJECT INTO THE MONITOR**

Do not put any solid objects or liquids such as water into the monitor. In case of an accident, unplug your monitor immediately and contact your dealer or iiyama service center. Using the monitor with any object inside may cause fire, electric shock or damage.

#### **INSTALL THE MONITOR ON A FLAT, STABLE SURFACE**

The monitor may cause an injury if it falls or is dropped.

#### **DO NOT USE THE MONITOR NEAR WATER**

Do not use where water may be splashed or spilt onto the monitor as it may cause fire or electric shock.

#### **OPERATE UNDER THE SPECIFIED POWER SUPPLY**

Be sure to operate the monitor only with the specified power supply. Use of an incorrect voltage will cause malfunction and may cause fire or electric shock.

#### **PROTECT THE CABLES**

Do not pull or bend the power cable and signal cable. Do not place the monitor or any other heavy objects on the cables. If damaged, the cables may cause fire or electric shock.

#### **ADVERSE WEATHER CONDITIONS**

It is advisable not to operate the monitor during a heavy thunder storm as the continual breaks in power may cause malfunction. It is also advised not to touch the plug in these circumstances as it may cause electric shock.

## CAUTION

### INSTALLATION LOCATION

Do not install the monitor where sudden temperature changes may occur, or in humid, dusty or smoky areas as it may cause fire, electric shock or damage. You should also avoid areas where the sun shines directly on the monitor.

### DO NOT PLACE THE MONITOR IN A HAZARDOUS POSITION

The monitor may topple and cause injury if not suitably located. Please also ensure that you do not place any heavy objects on the monitor, and that all cables are routed such that children may not pull the cables and possibly cause injury.

### MAINTAIN GOOD VENTILATION

Ventilation slots are provided to keep the monitor from overheating. Covering the slots may cause fire. To allow adequate air circulation, place the monitor at least 10cm (or 4 inches) from any walls. When removing the tilt stand, the ventilation slots on the back side of the monitor can be blocked. This may overheat the monitor and may cause fire or damage. Make sure to allow enough ventilation when removing the tilt stand. Operating the monitor on its back, side, upside down or on a carpet or any other soft material may also cause damage.

### DISCONNECT THE CABLES WHEN YOU MOVE THE MONITOR

When you move the monitor, turn off the power switch, unplug the monitor and be sure the signal cable is disconnected. If you do not disconnect them, it may cause fire or electric shock.

### UNPLUG THE MONITOR

If the monitor is not in use for a long period of time it is recommended that it is left unplugged to avoid accidents.

### HOLD THE PLUG WHEN DISCONNECTING

To disconnect the power cable or signal cable, always pull it by the plug. Never pull on the cable itself as this may cause fire or electric shock.

### DO NOT TOUCH THE PLUG WITH WET HANDS

Pulling or inserting the plug with wet hands may cause electric shock.

### WHEN YOU INSTALL THE MONITOR ON YOUR COMPUTER

Be sure the computer is strong enough to hold the weight of the monitor, otherwise, you may damage your computer.

### CAREFUL! PROTECT YOUR HANDS AND FINGERS

- Be careful not to hurt your fingers or hands when you change the height or the angle.
- Injury can occur if care is not taken to avoid finger contact with the displays base when adjusting the height. (Just for height adjustable model.)

### REMARK FOR 24/7 USAGE

This product is not specifically designed for 24/7 usage in all environments.

## OTHERS

### ERGONOMIC RECOMMENDATIONS

To eliminate eye fatigue, do not operate the monitor against a bright background or in a dark room. For optimal viewing comfort, the monitor should be just below eye level and 40-60 cm (16-24 inches) away from your eyes. When using the monitor over a prolonged time, a ten minute break every hour is recommended as looking at the screen continuously can cause eye strain.

## SPECIAL NOTES ON LCD MONITORS

The following symptoms are normal with LCD monitors and do not indicate a problem.

### NOTE

- When you first turn on the LCD monitor, the picture may not fit in the display area because of the type of computer that is used. In this case, adjust the picture position to the correct position.
- You may find slightly uneven brightness on the screen depending on the desktop pattern you use.
- Due to the nature of the LCD screen, an afterimage of the previous screen may remain after switching the image, when the same image is displayed for hours. In this case, the screen can be recovered slowly by changing the image or turning off the Power Switch for some hours.

## CUSTOMER SERVICE

### NOTE

- If you have to return your unit for service and the original packaging has been discarded, please contact your dealer or iiyama service center for advice or replacement packaging.

## CLEANING

### WARNING

- If you drop any materials or liquids such as water into the monitor when cleaning, unplug the power cable immediately and contact your dealer or iiyama service center.

### CAUTION

- For safety reasons, turn off the power switch and unplug the monitor before you clean it.

### NOTE

- To protect the LCD panel, do not scratch or rub the screen with a hard object.
- Never use any of the following strong solvents. These will damage the cabinet and the LCD screen.

Thinner	Spray-type cleaner
Benzine	Wax
Abrasive cleaner	Acid or Alkaline solvent

- Touching the cabinet with any product made from rubber or plastic for a long time may cause degeneration or loss of paint on the cabinet.

### CABINET

Stains can be removed with a cloth lightly moistened with a mild detergent solvent. Then wipe the cabinet with a soft dry cloth.

### LCD SCREEN

Periodic cleaning with a soft dry cloth is recommended.

Don't use tissue paper etc. because these will damage the LCD screen.

# BEFORE YOU OPERATE THE MONITOR

## FEATURES

- ◆ Supports Resolutions up to 3440 × 1440
- ◆ High Contrast 4000:1 (Typical), Adv. Contrast Function Available / Brightness 420cd/m<sup>2</sup> (Typical)
- ◆ Supports AMD FreeSync™ Premium Pro certified Range 48Hz - 165Hz (Overclock 180Hz), with HDR400 Technology
- ◆ Flicker - Free
- ◆ Quick Response Time 1ms (Gray to Gray) with OverDrive
- ◆ Moving Picture Response Time 0.4ms
- ◆ Blue Light Reducer
- ◆ Digital Character Smoothing
- ◆ 2 × 3W Stereo Speakers
- ◆ Standby Feature (VESA DPMS Compliant)
- ◆ VESA Mounting Standard (100mm×100mm) Compliant
- ◆ Keyhole for Security Lock

## CHECKING THE CONTENTS OF THE PACKAGE

The following accessories are included in your package. Check to see if they are enclosed with the monitor. If anything is missing or damaged, please contact your local iiyama dealer or regional iiyama office.

- Power Cable\*
- USB Cable
- Screw (4pcs) & Screwdriver (for Stand-Neck)
- Quick Start Guide
- HDMI Cable
- Stand-Base with a screw
- DisplayPort Cable
- Stand-Neck
- Safety Guide

### CAUTION

- \* The rating of the Power Cable enclosed in 120V area is 10A/125V. If you are using a power supply higher than this rating, then a power cable with a rating of 10A/250V must be used. However, all guarantees and warranties are void for any problems or damage caused by a power cable not supplied by iiyama. An approved power cable greater or equal to H05VVf, 3G, 0.75mm<sup>2</sup> must be used.



## INSTALLATION

- CAUTION** ■ Before installation, make sure the wall, ceiling or desktop arm is strong enough to hold the necessary weight of the monitor and the mount.

### < WALL MOUNTING >

- CAUTION** ■ When you use with the wall mounting, in consideration of thickness of the mounting stage, tighten the M4 Screws (4pcs) which “L” length is 13mm to fasten the monitor. Using the screw longer than this may cause electric shock or damage because it may contact with the electrical parts inside the monitor.

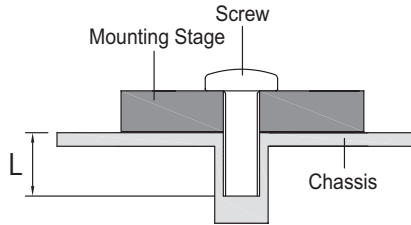

## < ROTATING THE DISPLAY >

The monitor is designed to be compatible in landscape mode.

ENGLISH

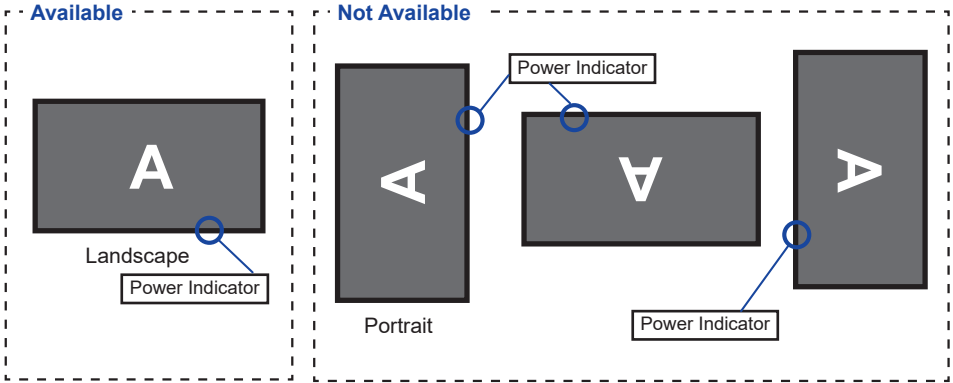

## FITTING AND REMOVAL OF STAND

### CAUTION

- Put the monitor on a stable surface. The monitor may cause injury or damage if it falls or is dropped.
- Do not give a strong impact to the monitor. It may cause damage.
- Unplug the monitor before removal or installation to avoid an electric shock or a damage.

### <Installation>

- ① As shown below, place all the contents taken out from the carton box on a flat surface with the monitor front face down.

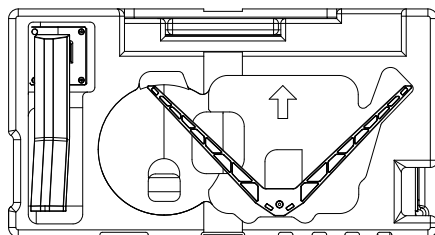

- ② Combine the Stand-Neck and the Stand-Base.

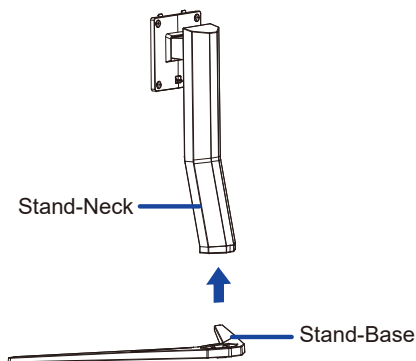

- ③ Use the 'thumb screw' provided to secure the base to the Stand-Neck.

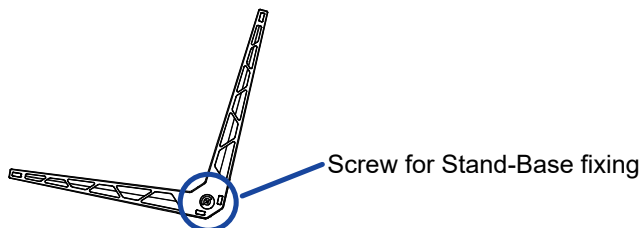

- ④ Remove the rear cushion.

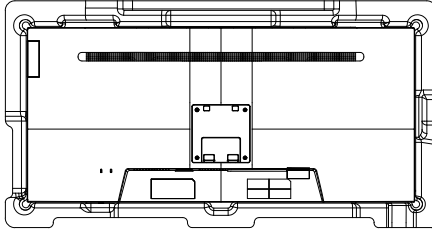

- ⑤ Attach the Stand to the monitor(VESA holes) and secure it in using the provided screws and screwdriver.

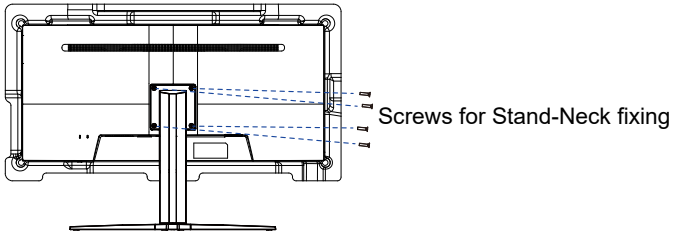

**<Removal>**

- ① Place the front side cushion on a flat surface and place the monitor with face down on it.  
② Remove the screws to remove the Stand from the monitor(VESA holes).  
③ Loosen the 'thumb screw' to remove the Stand-Base from the Stand-Neck.

## CONTROLS AND CONNECTORS

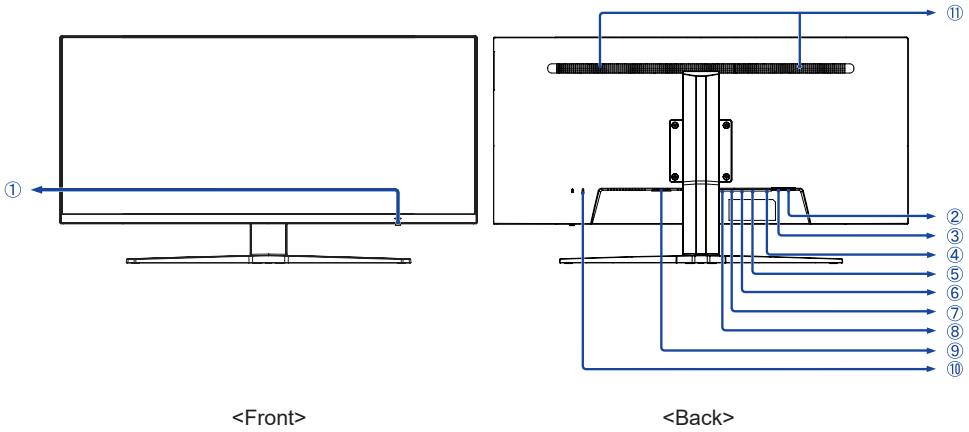

<Front>

<Back>

### ① Navigation button

- Power Switch / Menu / Power Indicator (  )

**NOTE** White : Power off  
Blue: Normal operation  
Orange: Standby mode

- Scroll Up / Input Select [ ▲ ]
- Scroll Down [ ▼ ]
- Left / ECO Mode [ ◀ ]
- Right / Volume [ ▶ ]

### ② USB Downstream Connector ( , 3.0 x 2, total: 5V, 900mA)

### ③ USB Upstream Connector ( IN)

### ④ Headphone connector ( )

### ⑤ DisplayPort Connector ( 2 )

### ⑥ DisplayPort Connector ( 1 )

### ⑦ HDMI Connector (HDMI2)

### ⑧ HDMI Connector (HDMI1)

### ⑨ AC Connector( ~ : Alternating current) ( ~ )

### ⑩ Keyhole for Security Lock

**NOTE** You can fasten a security lock and cable to prevent the monitor from being removed without your permission.

### ⑪ Speakers

## CONNECTING YOUR MONITOR

- ① Ensure that both the computer and the monitor are switched off.
- ② Connect the computer to the monitor with the signal cable.
- ③ Connect the computer to the monitor with the USB Cable.
- ④ Connect the Power Cable to the monitor first and then to the power source.
- ⑤ Turn on your monitor and computer.

**NOTE**

- Make sure that the building installation has a circuit breaker of 120/240V, 20A (maximum).
- The signal cables used for connecting the computer and monitor may vary with the type of computer used. An incorrect connection may cause serious damage to both the monitor and the computer. The cable supplied with the monitor is for a standard connector. If a special cable is required please contact your local iiyama dealer or regional iiyama office.
- Make sure you tighten the finger screws at each end of the signal cable.
- The Class I pluggable equipment Type A must be connected to protective earth.
- The socket-outlet shall be installed near the equipment and shall be easily accessible.
- Excessive sound pressure from ear-/headphones can cause hearing damage/hearing loss.

[Example of Connection]

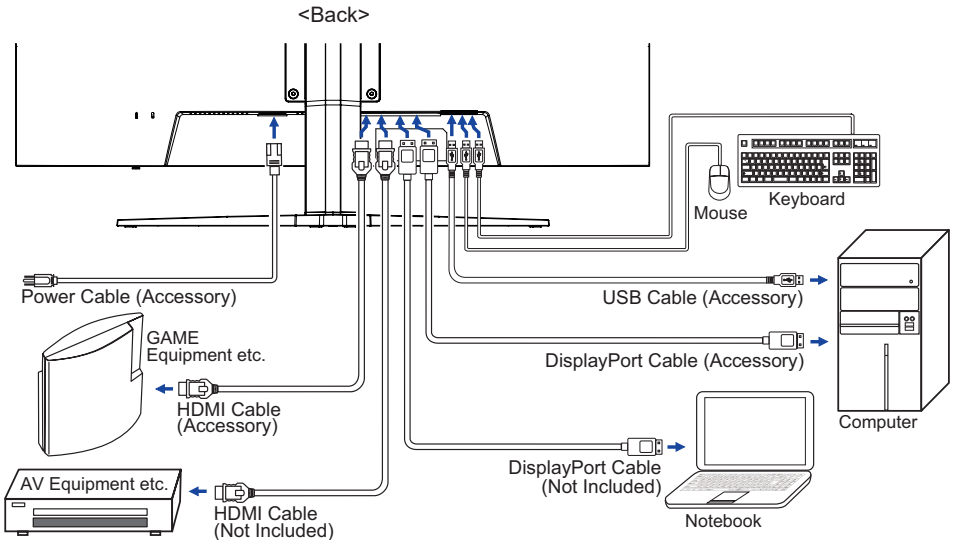

## COMPUTER SETTING

### ■ Signal Timing

Change to the desired signal timing listed on page 28: COMPLIANT TIMING.

## ADJUSTING THE HEIGHT AND THE VIEWING ANGLE

- For optimal viewing it is recommended to position yourself directly opposite to the full face of the monitor, then adjust the monitor's height and angle to your own preference.
- Hold the panel so that the monitor does not topple when you change the monitor's height or angle.
- You are able to adjust the monitor's height up to 110mm, 20° upward and 5° downward.

### NOTE

- Do not touch the LCD screen when you change the height or the angle. It may cause damage or break the LCD screen.
- Careful attention is required not to pinch your fingers or hands into the moving part of the stand when you change the height or the angle.
- Injury can occur if care is not taken to avoid finger contact with the displays base when adjusting the height.

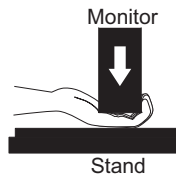
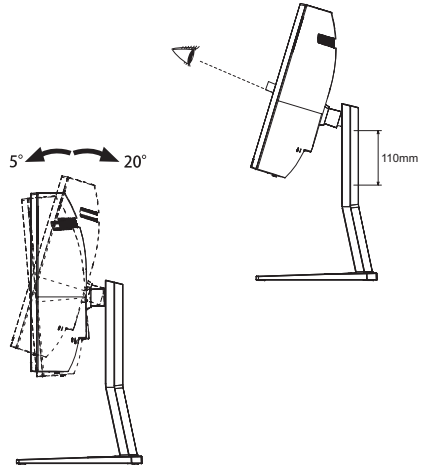

# OPERATING THE MONITOR

To create the best picture, your iiyama LCD monitor has been preset at the factory with the COMPLIANT TIMING shown on page 28. You are also able to adjust the picture by following the button operation shown below.

- 1 Press the MENU Button to start the On Screen Display feature. There are additional Menu items which can be switched by using the ◀ / ▶ Buttons.

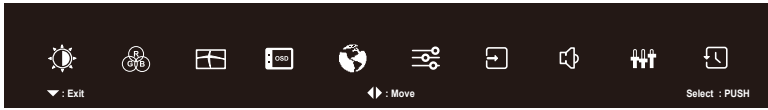

- 2 Select the Menu item which contains the adjustment icon relating to the adjustment you want to make. Press the MENU Button. Then, use the ▲ / ▼ Buttons to highlight the desired adjustment icon.
- 3 Press the MENU Button again. Use the ◀ / ▶ Buttons to make the appropriate adjustment or setting.
- 4 Press the ▼ Button to leave the menu, and the settings you just made would be automatically saved.

For example, to correct for OSD vertical position, select Menu item of OSD and then press the MENU Button. Then, select OSD Vertical Position by using the ▲ / ▼ Buttons. An adjustment page appears after you press the MENU Button.

Then, use the ◀ / ▶ Buttons to change the OSD vertical position settings. The OSD vertical position of the overall display should be changing accordingly while you are doing this.

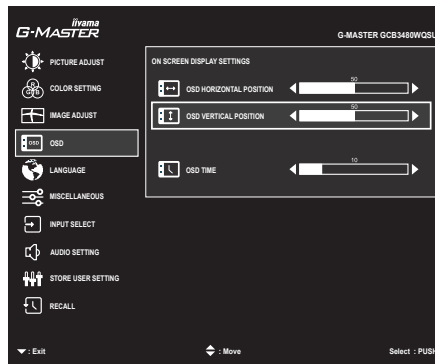

Press the ▼ Button lastly, it ends, all changes are saved in the memory.

## NOTE

- When button operations are aborted during adjustment, On-Screen Display disappears when the time set for the OSD Time has passed. Also, press the ▼ button to quickly turn off the On-Screen Display.
- Any changes are automatically saved in the memory when the On Screen Display disappears. Turning off the power should be avoided while using the Menu.
- All adjustments have only one setting which applies to all signal timings.



# ADJUSTMENT MENU CONTENTS



## Picture Adjust

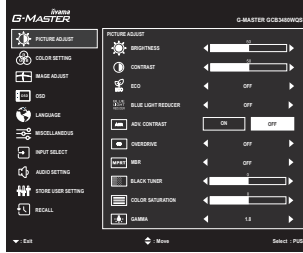

Adjustment Item	Problem / Option	Button to Press
Brightness *1,2	Too dull Too intense	
Contrast *2	Too dark Too bright	
ECO *2 <span style="float: right; border: 1px solid blue; padding: 2px;">Direct</span>	Off	Normal
	Mode1	Brightness of back-light is reduced.
	Mode2	Brightness of back-light is reduced more than Mode1.
	Mode3	Brightness of back-light is reduced more than Mode2.
Blue Light Reducer *2	Off	Typical
	Mode1	Blue light is reduced.
	Mode2	Blue light is reduced more than Mode1.
	Mode3	Blue light is reduced more than Mode2.
Adv. Contrast *2	On	Increased Contrast Ratio
	Off	Typical Contrast Ratio
Overdrive *2	Off / -2 / -1 / 0 / +1 / +2 It will improve the gray level response time of the LCD panel. A higher level results in a faster response time.	
MBR *2	Off / -2 / -1 / 0 / +1 / +2 It will improve the moving picture response time of the LCD panel. A higher level results in a faster response time.	
Black Tuner	From -5 to +5 You can adjust Dark shades.	

### Direct



You can skip the Menu items and directly display an option setting screen by using the following button operations.

- ECO : Press the Button when the Menu is not displayed.

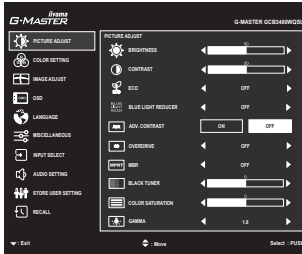

# Picture Adjust



Adjustment Item	Problem / Option	Button to Press
Color Saturation	Too weak Too strong	 
Gamma * <sup>2</sup>	You can set the Gamma. 1.8 / 2.2 / 2.6	

\*<sup>1</sup> Adjust the Brightness when you are using the monitor in a dark room and feel the screen is too bright.

\*<sup>2</sup> Adjustable / settable items depend on which item is activated. See page 23 Function Correlation Matrix for more details.



# Color Setting

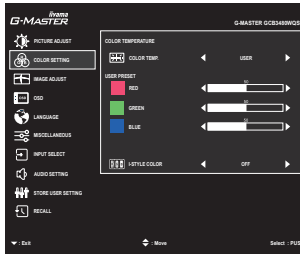



Adjustment Item	Problem / Option		Button to Press
Color Temp. *1	Cool	Cool color	
	Normal	Normal color	
	Warm	Warm color	
	sRGB *2	sRGB	
<p><b>NOTE</b></p> <ul style="list-style-type: none"> <li>sRGB is an international standard which defines and unifies the difference of color appearance between equipment.</li> <li>You can not adjust the Contrast, Brightness, i-Style Color, Adv. Contrast, Eco, Gamma and Blue Light Reducer during sRGB mode because those settings are locked.</li> </ul>			
User Preset *1	Red	Too weak	
	Green		
	Blue	Too strong	
i-Style Color *1	Off	Return to a state set by color adjustment except i-Style Color.	
	Standard	For general windows environment and monitor default setting.	
	Sport Game	For Sports game environment.	
	FPS Game	For FPS game environment.	
	Strategy Game	For Strategy game environment.	
	Text	For text editing and viewing in a word processing environment.	
	User Mode 1	Applies customized monitor settings.	
	User Mode 2	Applies customized monitor settings.	
User Mode 3	Applies customized monitor settings.		

\*1 Adjustable / settable items depend on which item is activated. See page 23 Function Correlation Matrix for more details.

\*2 sRGB is disabled when ECO is activated.

# Image Adjust



Adjustment Item	Problem / Option	Button to Press
Sharp and Soft	1 2 3 4 5 6 You can change the picture quality from 1 to 6 (sharp to soft). Press the ► Button to change the picture quality in numerical order. Press the ◀ Button to change the picture quality in reverse numerical order.	 
HDMI RGB Range	Auto	Automatically select color scale signal.
	Full	For full-range color scale signal.
	Limited	For limited color scale signal.
Direct Drive Mode *1,3,4.	On	Reduce the input-lag.
	Off	Typical
<b>NOTE</b> Changing Resolution and Refresh rate or turning Power Off/On might disable the Direct Drive function.		
Video Mode Adjust *4,5	Full Screen	Expansion display.
	Aspect Ratio *2	Expansion display of Aspect.
	Dot by Dot *2	Display the picture dot by dot.
HDR *1	On	For HDR (High Dynamic Range) signal.
	Off	For normal signal.
	Auto	Automatically switch to HDR signal.
FreeSync *5,6	On	Enable the FreeSync function.
	Off	The FreeSync function is turned off.
Overclock *7	Off	Disable the overclock function.
	180Hz	Enable the overclock function.

\*1 Adjustable / settable items depend on which item is activated. See page 23 Function Correlation Matrix for more details.

\*2 Option unavailable with 21:9 resolution.

\*3 Direct Drive Mode is disabled when Overdrive is activated.

\*4 Direct Drive Mode and Video Mode Adjust are disabled when FreeSync is activated.

\*5 FreeSync and Video Mode Adjust are disabled when Direct Drive Mode is activated.









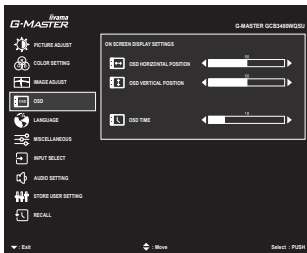



\*6 FreeSync is disabled when MBR is activated.

\*7 When overclock is enabled only DP can be displayed, HDMI does not display.



# OSD



Adjustment Item	Problem / Option	Button to Press
OSD Horizontal Position	OSD is too left OSD is too right	   
OSD Vertical Position	OSD is too low OSD is too high	   
OSD Time	You can set the OSD display duration time between 5 and 30 seconds.	   



# Language

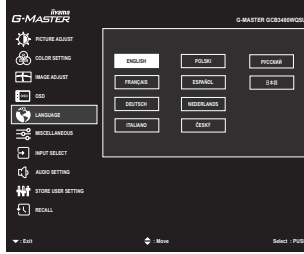

ENGLISH

Adjustment Item	Problem / Option				Button to Press
	English	English	Español	Spanish	
Language	Français	French	Nederlands	Dutch	
	Deutsch	German	Česky	Czech	
	Italiano	Italian	Русский	Russian	
	Polski	Polish	日本語	Japanese	



## Miscellaneous

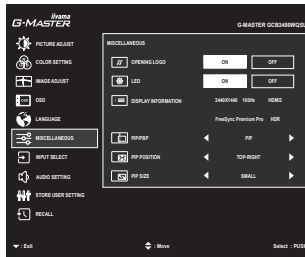

Adjustment Item	Problem / Option	Button to Press
Opening Logo	On	iiyama Logo displayed when the monitor is turned on.
	Off	iiyama Logo does not display when the monitor is turned on.
LED	On	The Power Indicator is turned On.
	Off	The Power Indicator is turned Off.
<p><b>NOTE</b> Turn Off the Power Indicator when you are bothered by the light.</p>		
Display Information	Displays information regarding the current input signal coming from the graphic card in your computer. <p><b>NOTE</b> See your graphic card user guide for more information about changing the resolution and refresh.</p>	
PiP/PbP *	Off	PiP/PbP Mode is turned off.
	PiP	Display the sub screen in the main screen.
	PbPLF	Divide display images in Right/Left.
	PbPFL	Swap images in Right/Left of the PbPLF screens.
PiP Position	Top-Right	Move the sub screen to the top right corner.
	Top-Left	Move the sub screen to the top left corner.
	Bottom-Right	Move the sub screen to the bottom right corner.
	Bottom-Left	Move the sub screen to the bottom left corner.
	Swap	Swap Main/Sub screens.
PiP Size	Middle	Normal size
	Large	Increase the size of the Sub screen.
	Small	Reduce the size of the Sub screen.

\* PiP = Picture In Picture

With this function, you can display two different pictures.

PbP = Picture By Picture

With this function, you can display max. two different pictures.

-Adjustable / settable items depend on which item is activated. See page 23 Function Correlation Matrix for more details.

-PiP/PbP can not be selected when FreeSync is activated.



## Input Select

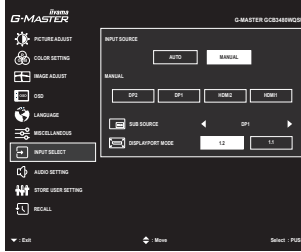

Adjustment Item		Problem / Option	Button to Press
Input Source <b>Direct</b>		Auto	Search for an available input source and select automatically.
	Manual	DP1	Select the Digital (DisplayPort1) input.
		DP2	Select the Digital (DisplayPort2) input.
		HDMI1	Select the Digital (HDMI1) input.
		HDMI2	Select the Digital (HDMI2) input.
<p><b>NOTE</b> At selected the AUTO, it will automatically be selected when just one source is available. If there are more input sources available and you select one of them, the AUTO option is not available.</p> <p>If multiple inputs are connected, the monitor may not recover the last one used after turning it off and on again.</p> <p>It is only possible when you set a specific source.</p>			
Sub Source	DP1	Select the Digital (DisplayPort1) input.	
	DP2	Select the Digital (DisplayPort2) input.	
	HDMI1	Select the Digital (HDMI1) input.	
	HDMI2	Select the Digital (HDMI2) input.	
DisplayPort Mode *	1.2	Standard	
	1.4	To be used when displaying 3440x1440 144Hz.	

\* DisplayPort Mode is disabled when FreeSync is activated.

### Direct

You can skip the Menu items and directly display an option setting screen by using the following button operations.



- Input Source : Press the ▲ Button when the Menu is not displayed.





## Audio Setting



Adjustment Item	Problem / Option		Button to Press
Volume <b>Direct</b>	Too soft Too loud		 
Mute Audio	On	Turn off the sound temporarily.	
	Off	Return the sound volume to the previous level.	
Audio Input	DP1	Select the Digital (DisplayPort1) input.	
	DP2	Select the Digital (DisplayPort2) input.	
	HDMI1	Select the Digital (HDMI1) input.	
	HDMI2	Select the Digital (HDMI2) input.	

### Direct

You can skip the Menu items and directly display an adjustment scale by using the following button operations.

- Volume : Press the ► Button when the Menu is not displayed.



## Store User Setting

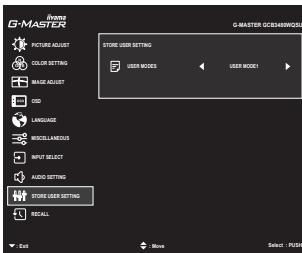

Adjustment Item	Problem / Option	Button to Press
User Modes	User Mode 1	Save the settings of the screen adjustment.
	User Mode 2	Save the settings of the screen adjustment.
	User Mode 3	Save the settings of the screen adjustment.

**NOTE**

You can memorize your customized monitor settings.

The following settings can be memorized:

Contrast, Brightness, Overdrive, Adv. Contrast, ECO, Volume, Mute Audio, Color Setting, Sharp and Soft, Black Tuner, Video Mode Adjust



## Recall

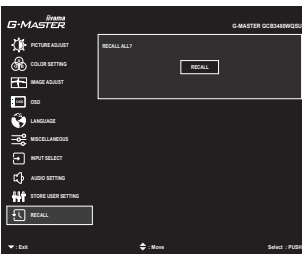

Adjustment Item	Problem / Option	Button to Press
Recall All	Factory-preset data is restored.	

## ■ Function Correlation Matrix

	Item to be selected											
	Brightness	Contrast	ECO	Blue Light Reducer	Adv. Contrast	Overdrive	MBR	Gamma	Color Temp.	i-Style Color	HDR	PIP/PbP
Item activated												
ECO	-	✓		✓	-	✓	-	✓	✓	✓	-	✓
Blue Light Reducer	✓	✓	✓		-	✓	-	-	-	-	-	✓
Adv. Contrast	-	-	-	-		✓	-	-	-	-	-	✓
MBR	-	-	-	-	-	-		✓	✓	-	-	-
i-Style Color	-	-	-	-	-	-	-	-	✓		-	✓
Direct Drive Mode	✓	✓	✓	-	✓	-	-	-	✓	✓	-	-
HDR	-	-	-	-	-	✓	-	-	-	-		-
PIP/PbP	✓	✓	✓	✓	-	-	-	✓	✓	-	-	

✓ : Available

- : Not available

### ● Lock Mode

#### <OSD Menu>

1. The OSD lock will be activated by pressing the ◀ button for 5 seconds. If you try to access the OSD by pressing any of the buttons, message "OSD Locked" will appear on the screen.
2. The OSD lock will be deactivated by pressing the ◀ button again for 5 seconds.

#### <Power Switch>

1. The power switch lock will be activated by pressing the ▶ button for 5 seconds. Locking the power switch means that won't be able to turn off the Monitor while the power switch is locked. If you press the power switch, message "Power Button Locked" will appear on the screen.
2. The power switch lock will be deactivated by pressing the ▶ button again for 5 seconds.

## STANDBY FEATURE

This product features the standby function. When activated, it automatically reduces unnecessary power consumption of the monitor when your computer is not in use.

There is a standby step the monitor takes as described below. The standby function, including any timer settings is configured by the operating system. Check your operating system manual for information on how this can be configured.

### ■ Standby Mode

When the video signal from the computer is off, the monitor enters into Standby Mode which reduces the power consumption to less than 0.5W\*. The screen becomes dark, and the power indicator turns to orange. From Standby Mode, the image reappears in several seconds when either the keyboard or the mouse are touched again.

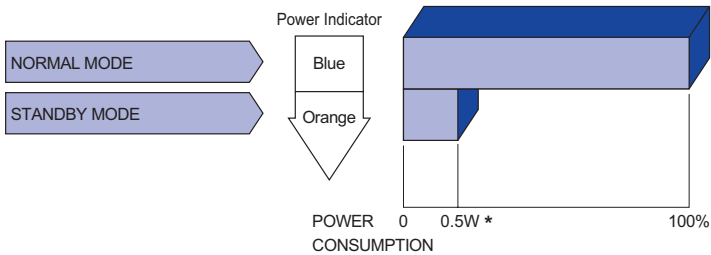

\* When the USB devices are not connected.

# TROUBLE SHOOTING

If the monitor fails to operate correctly, please follow the steps below for a possible solution.

1. Perform the adjustments described in OPERATING THE MONITOR, depending on the problem you have. If the monitor does not get a picture, skip to 2.
2. Consult the following items if you cannot find an appropriate adjustment item in OPERATING THE MONITOR or if the problem persists.
3. If you are experiencing a problem which is not described below or you cannot correct the problem, discontinue using the monitor and contact your dealer or iiyama service center for further assistance.

Problem	Check
① The picture does not appear.  (Power indicator is white.)  (Power indicator is blue.)  (Power indicator is orange.)	<input type="checkbox"/> The Power Cable is firmly seated in the socket. <input type="checkbox"/> The Power Switch is turned ON. <input type="checkbox"/> The AC socket is live. Please check with another piece of equipment.  <input type="checkbox"/> If the blank screen saver is in active mode, touch the keyboard or the mouse. <input type="checkbox"/> Increase the Contrast and/or Brightness. <input type="checkbox"/> The computer is ON. <input type="checkbox"/> The Signal Cable is properly connected. <input type="checkbox"/> The signal timing of the computer is within the specification of the monitor.  <input type="checkbox"/> If the monitor is in standby mode, touch the keyboard or the mouse. <input type="checkbox"/> The computer is ON. <input type="checkbox"/> The Signal Cable is properly connected. <input type="checkbox"/> The signal timing of the computer is within the specification of the monitor.
② The screen is not synchronized.	<input type="checkbox"/> The Signal Cable is properly connected. <input type="checkbox"/> The signal timing of the computer is within the specification of the monitor.
③ The screen position is not in the center.	<input type="checkbox"/> The signal timing of the computer is within the specification of the monitor.
④ The screen is too bright or too dark.	<input type="checkbox"/> The video output level of the computer is within the specification of the monitor.

## Problem

## Check

- |                                       |   |
|---------------------------------------|---|
| ⑤ The screen is shaking.              | <input type="checkbox"/> The power voltage is within the specification of the monitor.<br><input type="checkbox"/> The signal timing of the computer is within the specification of the monitor.  |
| ⑥ No sound.                           | <input type="checkbox"/> The audio equipment (computer etc.) is ON.<br><input type="checkbox"/> The Volume is turned up.<br><input type="checkbox"/> The Mute is OFF.<br><input type="checkbox"/> The audio output level of the audio equipment is within the specification of the monitor. |
| ⑦ The sound is too loud or too quiet. | <input type="checkbox"/> The audio output level of the audio equipment is within the specification of the monitor.  |

## RECYCLING INFORMATION

For better environment protection please don't dispose your monitor.  
Please visit our web site: <https://iiyama.com> for monitor recycling.

# APPENDIX

Design and specifications are subject to change without prior notice.

## SPECIFICATIONS : G-MASTER GCB3480WQSU-B1

Size Category	34"	
LCD Panel	Panel technology	VA
	Size	Diagonal: 34" (86.425cm)
	Pixel pitch	0.23175mm H × 0.23175mm V
	Brightness	420cd/m <sup>2</sup> (Typical), 160cd/m <sup>2</sup> (Default / Energy Saving)
	Contrast ratio	4000 : 1 (Typical), Adv. Contrast Function Available
	Viewable angle	Right / Left : 89° each, Up / Down : 89° each (Typical)
	Response time	1ms (Gray to Gray) with OverDrive, 5ms (Typical)
	MPRT	0.4ms
Display Colors	Approx. 16.7M	
Sync Frequency	HDMI1/2(without FreeSync): Horizontal: 30.0-160.0kHz, Vertical: 48-100Hz HDMI1/2(with FreeSync): Horizontal: 30.0-160.0kHz, Vertical: 48-100Hz DisplayPort1/2(without FreeSync): Horizontal: 30.0-250.0kHz, Vertical: 48-165Hz DisplayPort1/2(with FreeSync): Horizontal: 30.0-250.0kHz, Vertical: 48-165Hz DisplayPort1/2(with Overclock): Horizontal: 30.0-267.0kHz, Vertical: 48-180Hz	
Native Resolution	3440 × 1440, 4.9 MegaPixels	
Support max. resolution	HDMI1/2: 3440 × 1440 100Hz, DisplayPort1/2: 3440 × 1440 165Hz	
Input Connector	HDMI × 2, DisplayPort × 2	
Input Video Signal	HDMI, DisplayPort	
USB Standard	USB3.0 × 2 (total: DC5V, 900mA)	
Number of USB Ports	1 Upstream : Series B	
Connector shape	2 Downstream : Series A	
Headphone Connector	ø 3.5mm mini jack (Stereo)	
Speakers	3W × 2 (Stereo speakers)	
Maximum Screen Size	797.22mm W × 333.72mm H / 31.4" W × 13.1" H	
Power Source	100-240VAC, 50/60Hz, 1.0A	
Power Consumption*	51W typical, Standby mode: 0.5W maximum, Off mode: 0.3W maximum	
Dimensions / Net Weight	808.0 × 441.5 - 551.5 × 256.0mm / 31.8 × 17.4 - 21.7 × 10.1"(W×H×D) 7.6kg / 16.7lbs	
Tilt Angle	Upward: 20° Downward: 5°	
Environmental Considerations	Operating: Temperature 5 to 35°C / 41 to 95°F Humidity 10 to 80% (No condensation) Storage: Temperature -20 to 60°C / -4 to 140°F Humidity 10 to 90% (No condensation)	
Approvals	CE, UKCA, EAC	

**NOTE** \* When the USB devices are not connected.

## DIMENSIONS

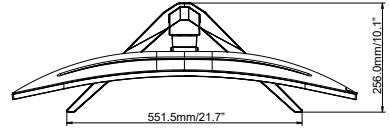
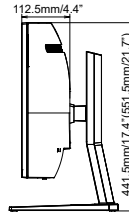
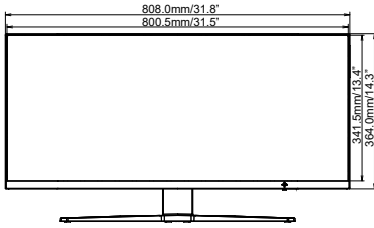

( ) : Maximum adjustment range

## COMPLIANT TIMING

Video Mode	Horizontal Frequency	Vertical Frequency	Dot Clock
800 × 600	37.879kHz	60.317Hz	40.000MHz
	46.875kHz	75.000Hz	49.500MHz
1024 × 768	48.363kHz	60.004Hz	65.000MHz
	60.023kHz	75.029Hz	78.750MHz
1280 × 1024	79.980kHz	75.020Hz	135.000MHz
1440 × 900	55.935kHz	59.887Hz	106.500MHz
1600 × 1200	75.000kHz	60.000Hz	162.000MHz
1680 × 1050	65.290kHz	60.000Hz	146.250MHz
1920 × 1080	66.590kHz	59.930Hz	138.500MHz
1920 × 2160	133.293kHz	59.988Hz	277.250MHz
2560 × 1440	88.787kHz	59.951Hz	241.500MHz
3440 × 1440	148.100kHz	100.000Hz	533.140MHz
	266.580kHz	180.000Hz	959.690MHz

### NOTE

\*1 Recommended to use on PbP mode.

\*2 HDMI input only. The source graphic card must be capable of supporting 3440 × 1440 resolution at 100Hz.

\*3 DisplayPort input only. The source graphic card must be capable of supporting 3440 × 1440 resolution at 180Hz.

The DisplayPort Mode setting has to be enabled as 1.2 or 1.4.