

USER MANUAL

ProLite

LCD Monitor

ENGLISH

ProLite XUB2792QSU
ProLite XU2792QSU

Thank you very much for choosing the iiyama LCD monitor.

We recommend that you take a few minutes to read this comprehensive manual carefully before installing and switching on the monitor. Please keep this manual in a safe place for your future reference.



Dear user, we congratulate you on the purchase of your iiyama LCD.

For details on warranty and locally used pixel policies that apply directly after installation of your product please check the iiyama website.

To report a fault, please contact your local support centre found at <https://iiyama.com>

Things to check before you call the iiyama information line

- | if the power cable is connected securely and turned on?
- | if the display has been turned on?
- | if the signal cable is connected securely and the correct input selected?
- | if the computer has been restarted with the display connected?
- | if the graphics card is correctly installed with the latest drivers possible?
- | if the correct native resolution has been selected via 'Display Properties'?
- | If the R/G/B signal configuration is correct?
- | if the displays On Screen Menu is shown?
- | if the correct brightness and contrast settings have been set?
- | if given display tolerances and compatibility have been considered?
- | if via the On Screen Menu you have performed a Factory Reset/Recall?

Before reporting the screen defect, please prepare the following information/evidence:

- | model number *
- | purchase receipt and serial number *
- | name and address for collection
- | telephone/fax number, for availability during the day
- | convenient collection date (date, time)
- | short description of the defect

Important Note:

If there is no fault found in the collected equipment after inspection, the transferring party shall incur charges for transport and administration.

If you have checked all of the above and there is still no picture, call our information line for assistance in your country.

Feedback on health and safety issues

If you have any health and safety concerns or questions about the product (including when using the product), please contact iiyama support through our website. You can also contact us by calling +31 204460404. After receiving your feedback, we will ask the responsible unit to handle it as soon as possible and a dedicated person will get back to you. Your feedback will also be recorded and incorporated into our evaluation for improvements.

* see the identification plate on the back of the case.

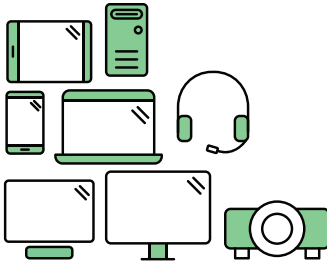

Say hello to a more sustainable product

IT products are associated with a wide range of sustainability risks throughout their life cycle. Human rights violations are common in the factories. Harmful substances are used both in products and their manufacture. Products can often have a short lifespan because of poor ergonomics, low quality and when they are not able to be repaired or upgraded.

This product is a better choice. It meets all the criteria in TCO Certified, the world's most comprehensive sustainability certification for IT products. Thank you for making a responsible product choice, that help drive progress towards a more sustainable future!

Criteria in TCO Certified have a life-cycle perspective and balance environmental and social responsibility. Conformity is verified by independent and approved verifiers that specialize in IT products, social responsibility or other sustainability issues. Verification is done both before and after the certificate is issued, covering the entire validity period. The process also includes ensuring that corrective actions are implemented in all cases of factory non-conformities. And last but not least, to make sure that the certification and independent verification is accurate, both TCO Certified and the verifiers are reviewed regularly.

Want to know more?

Read information about TCO Certified, full criteria documents, news and updates at [tcocertified.com](https://www.tcocertified.com). On the website you'll also find our Product Finder, which presents a complete, searchable listing of certified products.

CE MARKING DECLARATION OF CONFORMITY

This LCD monitor complies with the requirements of the EC/EU Directive 2014/30/EU "EMC Directive", 2014/35/EU "Low Voltage Directive", 2009/125/EC "ErP Directive" and 2011/65/EU "RoHS Directive".

The electro-magnetic susceptibility has been chosen at a level that gives correct operation in residential areas, business and light industrial premises and small-scale enterprises, inside as well as outside of the buildings. All places of operation are characterised by their connection to the public low voltage power supply system.

IYAMA CORPORATION: Wijkemeerstraat 8, 2131 HA Hoofddorp, The Netherlands

Model No. : PL2792Q



We recommend recycling of used product. Please contact your dealer or iiyama service center. Recycle information is obtained via the Internet, using the address: <https://iiyama.com>

You can access the Web page of different countries from there.

- We reserve the right to change specifications without notice.
- All trademarks used in this user manual are the property of their respective owners.
- Eprel registration number XUB2792QSU-B6 : 1684283 XUB2792QSU-W6 : 1684330 XU2792QSU-B6 : 1684338

TABLE OF CONTENTS

| | |
|---|----|
| FOR YOUR SAFETY..... | 1 |
| SAFETY PRECAUTIONS..... | 1 |
| SPECIAL NOTES ON LCD MONITORS..... | 4 |
| CUSTOMER SERVICE..... | 4 |
| CLEANING..... | 5 |
| BEFORE YOU OPERATE THE MONITOR..... | 6 |
| FEATURES..... | 6 |
| CHECKING THE CONTENTS OF THE PACKAGE..... | 6 |
| INSTALLATION..... | 7 |
| FITTING AND REMOVAL OF BASE : ProLite XUB2792QSU..... | 9 |
| FITTING AND REMOVAL OF BASE : ProLite XU2792QSU..... | 10 |
| CONTROLS AND CONNECTORS : ProLite XUB2792QSU..... | 11 |
| CONTROLS AND CONNECTORS : ProLite XU2792QSU..... | 12 |
| CONNECTING YOUR MONITOR : ProLite XUB2792QSU..... | 13 |
| CONNECTING YOUR MONITOR : ProLite XU2792QSU..... | 14 |
| DISCONNECTING YOUR MONITOR..... | 15 |
| COMPUTER SETTING..... | 15 |
| ADJUSTING THE HEIGHT AND THE VIEWING ANGLER : | |
| ProLite XUB2792QSU..... | 15 |
| ADJUSTING THE VIEWING ANGLE : ProLite XU2792QSU..... | 16 |
| OPERATING THE MONITOR..... | 17 |
| ADJUSTMENT MENU CONTENTS..... | 18 |
| STANDBY FEATURE..... | 27 |
| TROUBLE SHOOTING..... | 28 |
| RECYCLING INFORMATION..... | 29 |
| APPENDIX..... | 30 |
| SPECIFICATIONS : ProLite XUB2792QSU-B6 / XUB2792QSU-W6..... | 30 |
| SPECIFICATIONS : ProLite XU2792QSU-B6..... | 31 |
| DIMENSIONS : ProLite XUB2792QSU..... | 32 |
| DIMENSIONS : ProLite XU2792QSU..... | 32 |
| COMPLIANT TIMING..... | 33 |

FOR YOUR SAFETY

SAFETY PRECAUTIONS

WARNING

STOP OPERATING THE MONITOR WHEN YOU SENSE TROUBLE

If you notice any abnormal phenomena such as smoke, strange sounds or fumes, unplug the monitor and contact your dealer or iiyama service center immediately. Further use may be dangerous and can cause fire or electric shock.

NEVER REMOVE THE CABINET

High voltage circuits are inside the monitor. Removing the cabinet may expose you to the danger of fire or electric shock.

DO NOT PUT ANY OBJECT INTO THE MONITOR

Do not put any solid objects or liquids such as water into the monitor. In case of an accident, unplug your monitor immediately and contact your dealer or iiyama service center. Using the monitor with any object inside may cause fire, electric shock or damage.

INSTALL THE MONITOR ON A FLAT, STABLE SURFACE

The monitor may cause an injury if it falls or is dropped.

DO NOT USE THE MONITOR NEAR WATER

Do not use where water may be splashed or spilt onto the monitor as it may cause fire or electric shock.

OPERATE UNDER THE SPECIFIED POWER SUPPLY

Be sure to operate the monitor only with the specified power supply. Use of an incorrect voltage will cause malfunction and may cause fire or electric shock.

PROTECT THE CABLES

Do not pull or bend the power cable and signal cable. Do not place the monitor or any other heavy objects on the cables. If damaged, the cables may cause fire or electric shock.

ADVERSE WEATHER CONDITIONS

It is advisable not to operate the monitor during a heavy thunder storm as the continual breaks in power may cause malfunction. It is also advised not to touch the plug in these circumstances as it may cause electric shock.

CAUTION

INSTALLATION LOCATION

Do not install the monitor where sudden temperature changes may occur, or in humid, dusty or smoky areas as it may cause fire, electric shock or damage. You should also avoid areas where the sun shines directly on the monitor.

DO NOT PLACE THE MONITOR IN A HAZARDOUS POSITION

The monitor may topple and cause injury if not suitably located. Please also ensure that you do not place any heavy objects on the monitor, and that all cables are routed such that children may not pull the cables and possibly cause injury.

MAINTAIN GOOD VENTILATION

Ventilation slots are provided to keep the monitor from overheating. Covering the slots may cause fire. To allow adequate air circulation, place the monitor at least 10cm (or 4 inches) from any walls.

When removing the tilt stand, the ventilation slots on the back side of the monitor can be blocked. This may overheat the monitor and may cause fire or damage. Make sure to allow enough ventilation when removing the tilt stand. Operating the monitor on its back, side, upside down or on a carpet or any other soft material may also cause damage.

DISCONNECT THE CABLES WHEN YOU MOVE THE MONITOR

When you move the monitor, turn off the power switch, unplug the monitor and be sure the signal cable is disconnected. If you do not disconnect them, it may cause fire or electric shock.

UNPLUG THE MONITOR

If the monitor is not in use for a long period of time it is recommended that it is left unplugged to avoid accidents.

HOLD THE PLUG WHEN DISCONNECTING

To disconnect the power cable or signal cable, always pull it by the plug. Never pull on the cable itself as this may cause fire or electric shock.

DO NOT TOUCH THE PLUG WITH WET HANDS

Pulling or inserting the plug with wet hands may cause electric shock.

WHEN YOU INSTALL THE MONITOR ON YOUR COMPUTER

Be sure the computer is strong enough to hold the weight of the monitor, otherwise, you may damage your computer.

CAREFUL! PROTECT YOUR HANDS AND FINGERS

- Be careful not to hurt your fingers or hands when you change the height or the angle.
- Injury can occur if care is not taken to avoid finger contact with the displays base when adjusting the height. (Just for height adjustable model.)

REMARK FOR 24/7 USAGE

This product is not specifically designed for 24/7 usage in all environments.

REMARK SPECIFIC TO DESKTOP USE

This product is designed for desktop use, not for digital signage (electronic signboard) applications such as ceiling hanging or wall mounting.

DO NOT TILT THE MONITOR DOWNWARD TOO FAR

To avoid potential screen damage such as LCD panel peeling from the bezel, ensure that the monitor does not tilt downward beyond its adjustable range.

DO NOT USE ALCOHOL OR DISINFECTANTS ON THE MONITOR

Do not spray alcohol or disinfectants directly onto the monitor or use them near the monitor. Also, do not wipe the monitor with a cloth or sheet that contains alcohol or disinfectants. These may cause discoloration, deterioration, or cracking of the cabinet, damage to the surface treatment of the LCD panel, and deterioration of components.

ERGONOMIC RECOMMENDATIONS

To eliminate eye fatigue, do not operate the monitor against a bright background or in a dark room. For optimal viewing comfort, the monitor should be just below eye level and 40-60 cm (16-24 inches) away from your eyes. When using the monitor over a prolonged time, a ten minute break every hour is recommended as looking at the screen continuously can cause eye strain.

SPECIAL NOTES ON LCD MONITORS

The following symptoms are normal with LCD monitors and do not indicate a problem.

NOTE

- When you first turn on the LCD monitor, the picture may not fit in the display area because of the type of computer that is used. In this case, adjust the picture position to the correct position.
- You may find slightly uneven brightness on the screen depending on the desktop pattern you use.
- Due to the nature of the LCD screen, an afterimage of the previous screen may remain after switching the image, when the same image is displayed for hours. In this case, the screen can be recovered slowly by changing the image or turning off the Power Switch for some hours.

CUSTOMER SERVICE

NOTE

- If you have to return your unit for service and the original packaging has been discarded, please contact your dealer or iiyama service center for advice or replacement packaging.

CLEANING

WARNING

- If you drop any materials or liquids such as water into the monitor when cleaning, unplug the power cable immediately and contact your dealer or iiyama service center.
- For safety reasons, turn off the power switch and unplug the monitor before you clean it.

CAUTION

- Do not spray alcohol or disinfectants directly onto the monitor or use them near the monitor. Also, do not wipe the monitor with a cloth or sheet that contains alcohol or disinfectants. These may cause discoloration, deterioration, or cracking of the cabinet, damage to the surface treatment of the LCD panel, and deterioration of components.
- To avoid potential damage on the monitor (LCD panel / cabinet / connector terminals) or accessories, never use the following strong solvents or cleaning sheets. These may cause discoloration, deterioration, or cracking of the cabinet, damage to the surface treatment of the LCD panel, and deterioration of components.

| | |
|---|-----------------------------|
| Benzene | Hypochlorous acid water |
| Thinner | Acidic or alkaline solvents |
| Alcohol | Wax |
| Bleach | Abrasives |
| Peroxide | Office equipment cleaner |
| Acetone | Glass cleaner |
| Methylene chloride | Tissue paper |
| Toluene | Wet tissue |
| Ammonia | Chemical cloth |
| Sodium hypochlorite solution (Chlorine bleach) | Cleaning paper |
| | etc. |

NOTE

- To protect the LCD panel, do not scratch or rub the screen with a hard object.
- Do not leave the LCD panel wet. If water droplets or the like get on it, immediately wipe it off with a dry, soft cloth. Leaving it on may cause discoloration or stains on the LCD panel. In addition, if moisture gets inside the monitor, it may cause damage.
- Touching the cabinet with any product made from rubber or plastic for a long time may cause degeneration or loss of paint on the cabinet.

Regular care

Gently wipe the cabinet with a soft, dry and clean cloth. If your monitor is particularly dirty, soak the cloth in a mild detergent thoroughly diluted with water, wring it out tightly, and then wipe the dirt off. Then immediately wipe it with a soft, dry cloth.

Alcohol disinfection

Alcohol disinfection may cause discoloration, deterioration, or cracking of the cabinet, damage to the surface treatment of the LCD panel, and deterioration of components. Instead, we recommend disinfecting your hands away from the monitor before and after use.

If you absolutely must disinfect the monitor with alcohol, please understand above warnings and cautions in advance. Also, avoid frequent alcohol disinfection.

BEFORE YOU OPERATE THE MONITOR

FEATURES

- ◆ Supports Resolutions up to 2560 × 1440
- ◆ High Contrast 1300:1 (Typical), Adv. Contrast Function Available / Brightness 250cd/m² (Typical)
- ◆ Moving Picture Response Time 0.4ms
- ◆ Supports AMD FreeSync™ technology
- ◆ Blue Light Reducer
- ◆ Flicker Free
- ◆ Digital Character Smoothing
- ◆ 2 × 2W Stereo Speakers
- ◆ Standby Feature
- ◆ VESA Mounting Standard (100mm×100mm) Compliant
- ◆ Keyhole for Security Lock

CHECKING THE CONTENTS OF THE PACKAGE

The following accessories are included in your package. Check to see if they are enclosed with the monitor. If anything is missing or damaged, please contact your local iiyama dealer or regional iiyama office.

- Power Cable*¹
- USB Cable
- Stand-Base*³
- Quick Start Guide
- HDMI Cable
- Stand-Neck
- Screwdriver*²
- DisplayPort Cable
- Stand-Base with a screw*²
- Safety Guide

CAUTION

*¹ All guarantees and warranties are void for any problems or damage caused by a power cable not supplied by iiyama.

An approved power cable greater or equal to H05VVF, 3G, 0.75mm² must be used.

*² Accessory for ProLite XUB2792QSU

*³ Accessory for ProLite XU2792QSU

INSTALLATION

CAUTION

- This product is designed for desktop use, not for digital signage (electronic signboard) applications such as ceiling hanging or wall mounting.
- Before installation, make sure the wall, ceiling or desktop arm is strong enough to hold the necessary weight of the monitor and the mount.
- The monitor angle should be within 22° upward and 5° downward. This product cannot be used facing upward or downward beyond this range.
- If the monitor is used (installed) at an angle more than 5° downward, the LCD may peel off from the bezel and fall, resulting in damage. In addition, such cases will not be covered by support or warranty.

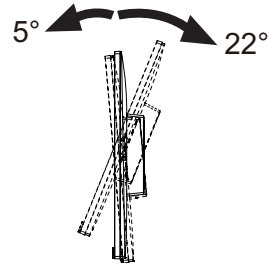

[DISPLAY ARM OR DESK ARM STAND]

CAUTION

- When you use with the display arm or desk arm stand, in consideration of thickness of the mounting stage, tighten the M4 Screws (4pcs) which "L" length is 7mm to fasten the monitor. Using the screw longer than this may cause electric shock or damage because it may contact with the electrical parts inside the monitor.

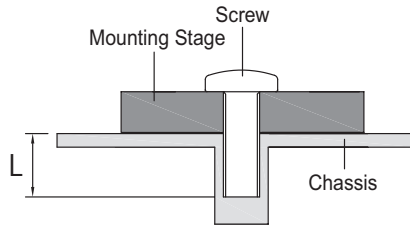

[ROTATING THE MONITOR]

• ProLite XUB2792QSU

The monitor is designed to be compatible with both landscape and portrait modes. Portrait display must be adjusted using the display settings of the connected device.

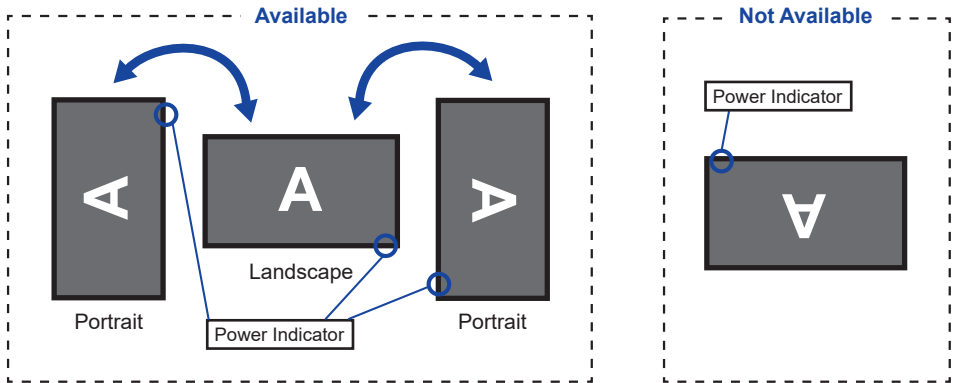

With Stand:

NOTE

- Adjust the monitor's height before panel rotation.
- Attempting to rotate the panel forcibly without adjusting the stand height may cause damage to the panel or the stand.

• ProLite XU2792QSU

The monitor is designed to be compatible only with the landscape mode.

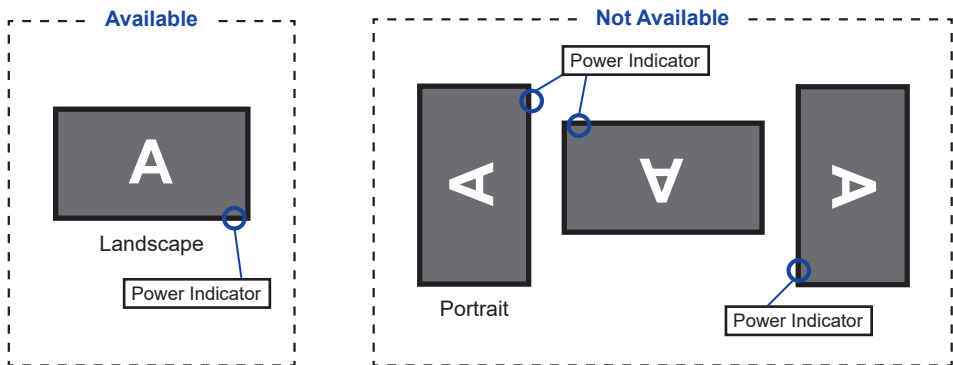

FITTING AND REMOVAL OF BASE : ProLite XUB2792QSU

CAUTION

- Put the monitor on a stable surface. The monitor may cause injury or damage if it falls or is dropped.
- Do not give a strong impact to the monitor. It may cause damage.
- Unplug the monitor before removal or installation to avoid an electric shock or a damage.

<Installation>

- ① Put a piece of soft cloth on the table beforehand to prevent the monitor from being scratched. Lay the monitor flat on a table with front face down.
- ② Install the Stand-Neck to the monitor and then tighten the 'thumb screw' with the provided screwdriver to secure them.

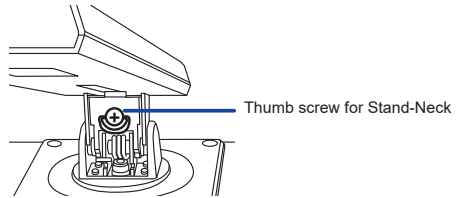
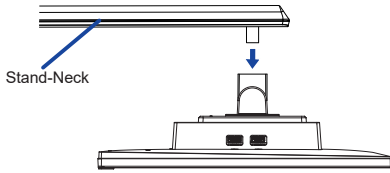

- ③ Install the Stand-Base to the Stand-Neck and then tighten the 'thumb screw' to secure them.

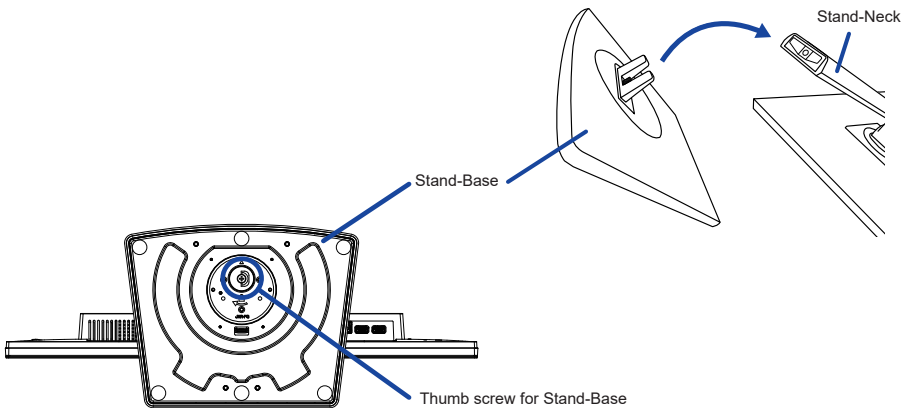

<Removal>

- ① Put a piece of soft cloth on the table beforehand to prevent the monitor from being scratched. Lay the monitor flat on a table with front face down.
- ② Loosen the 'thumb screw' to remove the Stand-Base from the Stand-Neck.
- ③ Loosen the 'thumb screw' with the provided screwdriver to remove the Stand-Neck from the monitor.

FITTING AND REMOVAL OF BASE : ProLite XU2792QSU

CAUTION

- Put the monitor on a stable surface. The monitor may cause injury or damage if it falls or is dropped.
- Do not give a strong impact to the monitor. It may cause damage.
- Unplug the monitor before removal or installation to avoid an electric shock or a damage.

<Installation>

- ① Put a piece of soft cloth on the table beforehand to prevent the monitor from being scratched. Lay the monitor flat on a table with front face down.
- ② Hold the monitor and install the Stand-Neck to the monitor until it clicks to secure.
- ③ Install the Stand-Base to the Stand-Neck.

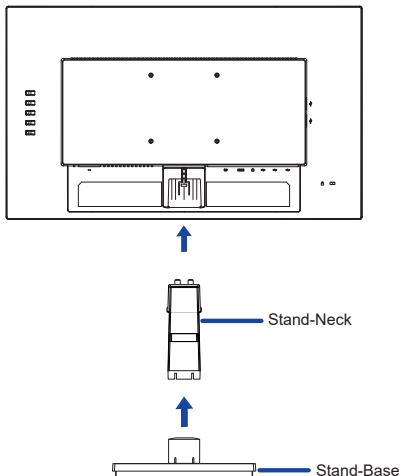

<Removal>

- ① Put a piece of soft cloth on the table beforehand to prevent the monitor from being scratched. Lay the monitor flat on a table with front face down.
- ② Keep pressing the Hooks inward to pull out the Stand-Base.
- ③ Press the Hook on the back of the monitor and remove the Stand-Neck from the monitor.
- ④ Pull and hold the Cable Holder toward you, slide it to the left and remove it.

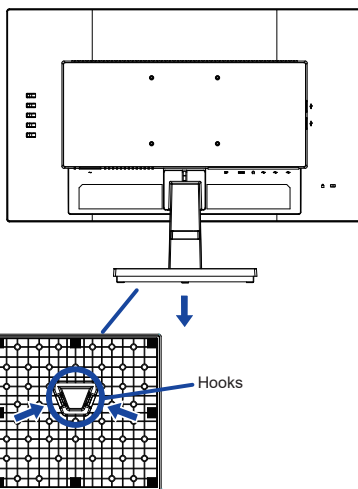
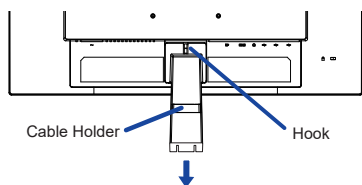

CONTROLS AND CONNECTORS : ProLite XUB2792QSU

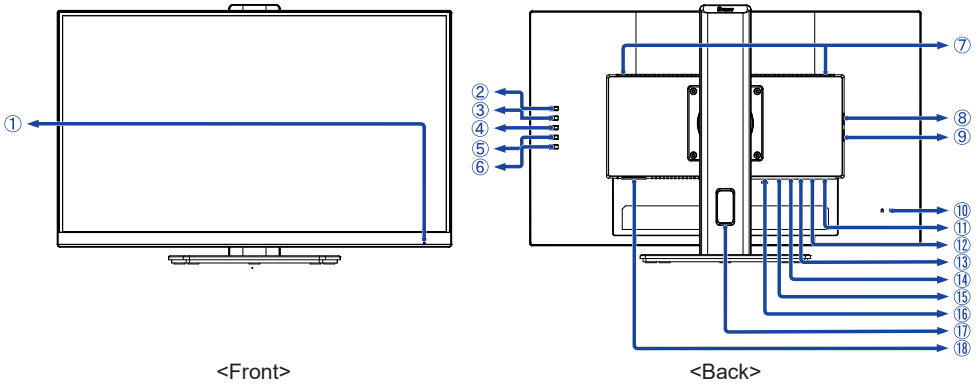

ENGLISH

① Power Indicator

NOTE Blue: Normal operation
Orange: Standby mode

② Signal Select / Exit Button (INPUT) *

③ + / Volume Button (+) *

④ - / Eco Button (-) *

⑤ Menu Button (MENU)

⑥ Power Switch (⏻)

⑦ Speakers

⑧ USB Downstream Connector (USB 3.2 Gen 1: 5Gbps, 5V, 900mA)

⑨ USB Downstream Connector (USB 3.2 Gen 1: 5Gbps, 5V, 900mA)

⑩ Keyhole for Security Lock

NOTE You can fasten a security lock and cable to prevent the monitor from being removed without your permission.

⑪ USB Downstream Connector (USB 3.2 Gen 1: 5Gbps, 5V, 900mA)

⑫ USB Downstream Connector (USB 3.2 Gen 1: 5Gbps, 5V, 900mA)

⑬ USB Upstream Connector (USB)

⑭ Headphone Connector ()

NOTE Proper operation of connected external devices other than headphones is not guaranteed.

⑮ DisplayPort Connector (DP)

⑯ HDMI Connector (HDMI)

⑰ Cable Hole

⑱ AC Connector (~ : Alternating current)

* You can skip the Menu items and directly display an option setting screen or an adjustment scale.

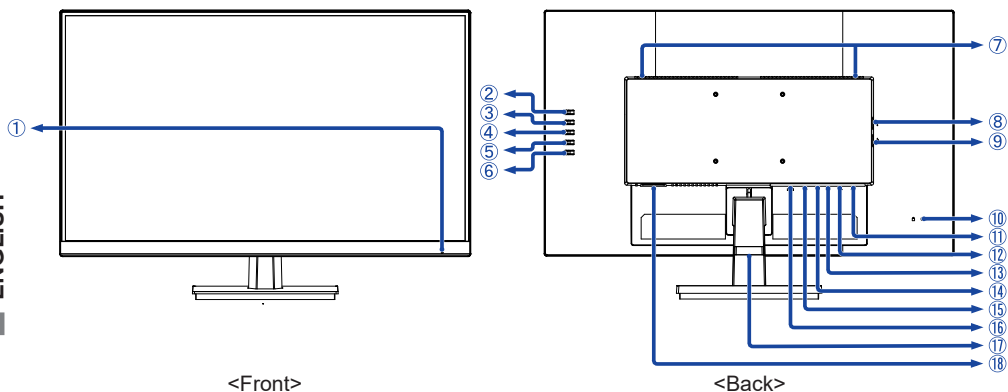

① Power Indicator

NOTE Blue: Normal operation
Orange: Standby mode

② Signal Select / Exit Button (INPUT) *

③ + / Volume Button (+) *

④ - / Eco Button (-) *

⑤ Menu Button (MENU)

⑥ Power Switch (⏻)

⑦ Speakers

⑧ USB Downstream Connector (🔌 USB3.2 Gen 1: 5Gbps, 5V, 900mA)

⑨ USB Downstream Connector (🔌 USB3.2 Gen 1: 5Gbps, 5V, 900mA)

⑩ Keyhole for Security Lock

NOTE You can fasten a security lock and cable to prevent the monitor from being removed without your permission.

⑪ USB Downstream Connector (🔌 USB3.2 Gen 1: 5Gbps, 5V, 900mA)

⑫ USB Downstream Connector (🔌 USB3.2 Gen 1: 5Gbps, 5V, 900mA)

⑬ USB Upstream Connector (🔌)

⑭ Headphone Connector (🎧)

NOTE Proper operation of connected external devices other than headphones is not guaranteed.

⑮ DisplayPort Connector (DP)

⑯ HDMI Connector (HDMI)

⑰ Cable Holder

⑱ AC Connector (~ : Alternating current)

* You can skip the Menu items and directly display an option setting screen or an adjustment scale.

CONNECTING YOUR MONITOR : ProLite XUB2792QSU

- ① Ensure that both the computer and the monitor are switched off.
- ② Connect the computer to the monitor with the signal cable.
- ③ Connect the computer to the monitor with the USB Cable.
- ④ Connect the Power Cable to the monitor first and then to the power source.
- ⑤ Turn on your monitor and computer.

NOTE

- Make sure that the building installation has a circuit breaker of 120/240V, 20A (maximum).
- The signal cables used for connecting the computer and monitor may vary with the type of computer used. An incorrect connection may cause serious damage to both the monitor and the computer. The cable supplied with the monitor is for a standard connector. If a special cable is required please contact your local iiyama dealer or regional iiyama office.
- Make sure you tighten the finger screws at each end of the signal cable.
- The Class I pluggable equipment Type A must be connected to protective earth.
- The socket-outlet shall be installed near the equipment and shall be easily accessible.
- Excessive sound pressure from ear-/headphones can cause hearing damage/hearing loss.

[Example of Connection]

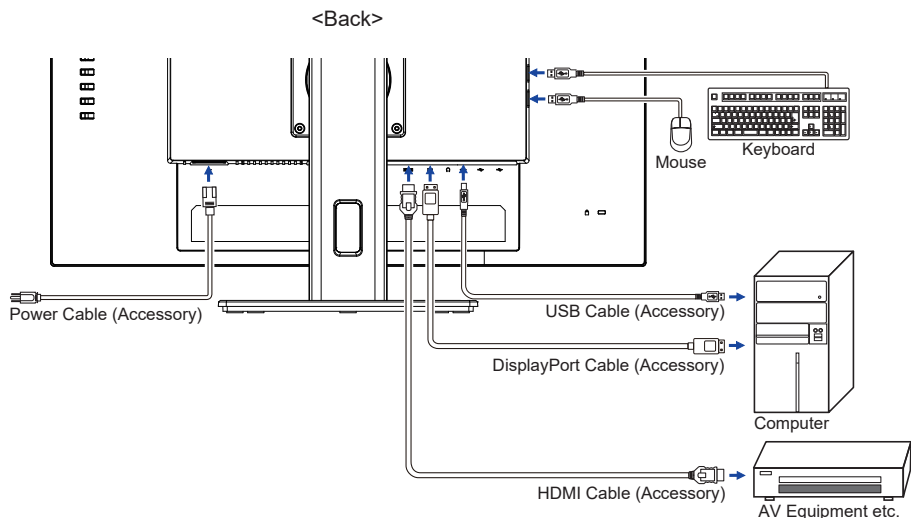

[Collect Cables]

Put the cables through the cable hole to bundle them.

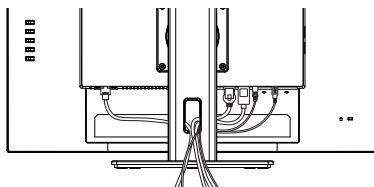

CONNECTING YOUR MONITOR : ProLite XU2792QSU

- ① Ensure that both the computer and the monitor are switched off.
- ② Connect the computer to the monitor with the signal cable.
- ③ Connect the computer to the monitor with the USB Cable.
- ④ Connect the Power Cable to the monitor first and then to the power source.
- ⑤ Turn on your monitor and computer.

NOTE

- Make sure that the building installation has a circuit breaker of 120/240V, 20A (maximum).
- The signal cables used for connecting the computer and monitor may vary with the type of computer used. An incorrect connection may cause serious damage to both the monitor and the computer. The cable supplied with the monitor is for a standard connector. If a special cable is required please contact your local iiyama dealer or regional iiyama office.
- Make sure you tighten the finger screws at each end of the signal cable.
- The Class I pluggable equipment Type A must be connected to protective earth.
- The socket-outlet shall be installed near the equipment and shall be easily accessible.
- Excessive sound pressure from ear-/headphones can cause hearing damage/hearing loss.

[Example of Connection]

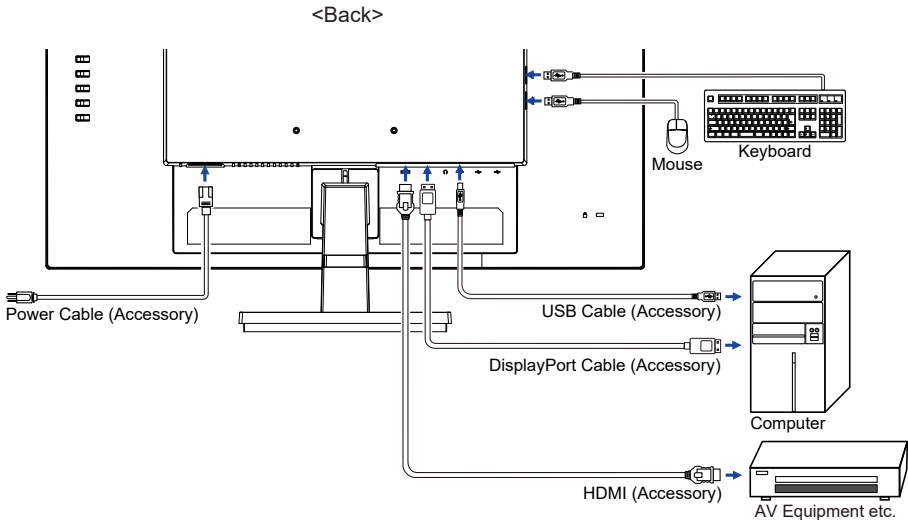

[Collect Cables]

Put the cables through the Cable Holder to bundle them.

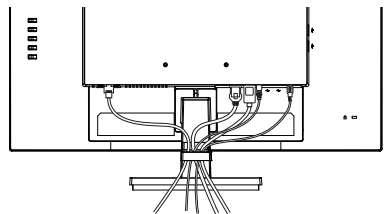

DISCONNECTING YOUR MONITOR

- ① Ensure that both the computer and the monitor are switched off.
- ② Disconnect the power source first and then the Power Cable from the monitor.
- ③ Disconnect the USB cable from the computer and the monitor.
- ④ Disconnect the signal cable from the computer and the monitor.

COMPUTER SETTING

- Signal Timing
Change to the desired signal timing listed on page 33: COMPLIANT TIMING.

ADJUSTING THE HEIGHT AND THE VIEWING ANGLER : ProLite XUB2792QSU

- For optimal viewing it is recommended to position yourself directly opposite to the full face of the monitor, then adjust the monitor's height and angle to your own preference.
- Hold the panel so that the monitor does not topple when you change the monitor's height or angle.
- You are able to adjust the monitor's height up to 150mm, angle up to 45° right and left, 22° upward and 5° downward.

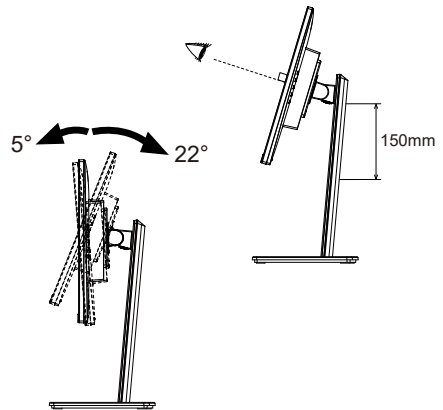

NOTE

- Do not touch the LCD screen when you change the height or the angle. It may cause damage or break the LCD screen.
- Careful attention is required not to pinch your fingers or hands into the moving part of the stand when you change the angle.
- Injury can occur if care is not taken to avoid finger contact with the displays base when adjusting the height.

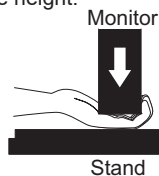
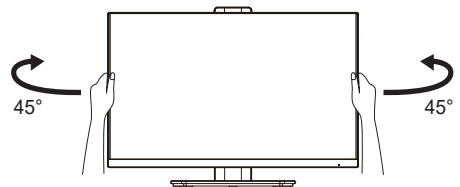

ADJUSTING THE VIEWING ANGLE : ProLite XU2792QSU

- For optimal viewing it is recommended to look at the full face of the monitor.
- Hold the stand so that the monitor does not topple when you change the monitor's angle.
- You are able to adjust the monitor's angle up to 21.5° upward, 3.5° downward.
- In order to ensure a healthy and relaxed body position when using the monitor at visual display workstations, it is recommended that the adjusted tilt angle should not exceed 10°. Adjust the monitor's angle to your own preference.

NOTE

- Do not touch the LCD screen when you change the angle. It may cause damage or break the LCD screen.
- Careful attention is required not to catch your fingers or hands when you change the angle.

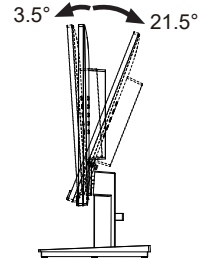
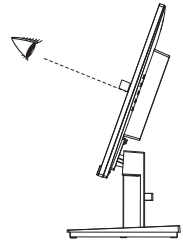

OPERATING THE MONITOR

To create the best picture, your iiyama LCD monitor has been preset at the factory with the COMPLIANT TIMING shown on page 33. You are also able to adjust the picture by following the button operation shown below.

- ① Press the MENU Button to start the On Screen Display feature. There are additional Menu items which can be switched by using the + / – Buttons.



- ② Select the Menu item which contains the adjustment icon relating to the adjustment you want to make. Press the MENU Button. Then, use the + / – Buttons to highlight the desired adjustment icon.
- ③ Press the MENU Button again. Use the + / – Buttons to make the appropriate adjustment or setting.
- ④ Press the INPUT Button to leave the menu, and the settings you just made would be automatically saved.

For example, to correct for OSD vertical position, select "OSD SETTINGS" of Menu item and then press the MENU Button. Then, select "OSD Vertical Position" by using the + / – Buttons. An adjustment page appears after you press the MENU Button.

Then, use the + / – Buttons to change the OSD vertical position settings. The OSD vertical position should be changing accordingly while you are doing this.

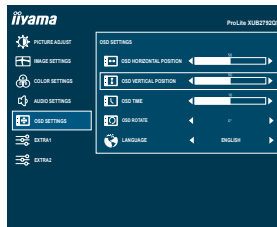

Press the INPUT Button lastly, it ends, all changes are saved in the memory.

NOTE

- When button operations are aborted during adjustment, On-Screen Display disappears when the time set for the OSD Time has passed. Also, the INPUT button can be used to return previous menu and turn off the On-Screen Display.
- Any changes are automatically saved in the memory when the On Screen Display disappears. Turning off the power should be avoided while using the Menu.

ADJUSTMENT MENU CONTENTS

Picture Adjust

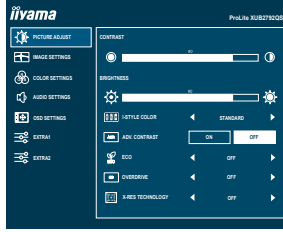

| Adjustment Item | Problem / Option | | Button to Press |
|--------------------|-------------------------|---|-----------------|
| Contrast *1 | Too dull Too intense | | + - |
| Brightness *1,2 | Too dark Too bright | | + - |
| i-Style Color *1,2 | Off | Return to a state set by color adjustment except i-Style Color. | |
| | Standard | For general windows environment and monitor default setting | |
| | Text | For text editing and viewing in a word processing environment | |
| | Internet | For internet environment | |
| | Game | For PC game environment | |
| | Movie | For movie and video environment | |
| | Sports | For sport environment | |
| Adv. Contrast *1 | On | Increased Contrast Ratio | |
| | Off | Typical Contrast Ratio | |
| Eco *1 | Off | Normal | |
| | Mode1 | Brightness of back-light is reduced. | |
| | Mode2 | Brightness of back-light is reduced more than Mode1. | |
| | Mode3 | Brightness of back-light is reduced more than Mode2. | |

NOTE

Adv. Contrast adjusts brightness according to the image, and improve the contrast ratio during movie playing.
 Contrast, Brightness, i-Style Color, Eco, Gamma and Color Temp. cannot be adjusted and selected while Adv. Contrast is active.

Direct

You can skip the Menu items and directly display an option setting screen by using the following button operations.

- Eco: Press the – Button when the Menu is not displayed.



Picture Adjust

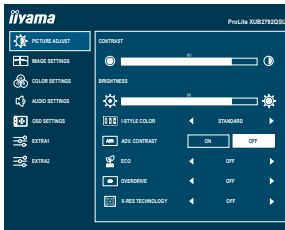

| Adjustment Item | Problem / Option | | Button to Press |
|------------------|--|---|--|
| Overdrive *3 | Off / 1 / 2 / 3 / 4 / 5 It will improve the gray level response time of the LCD panel. A higher level results in a faster response time. | |  <input data-bbox="975 395 1028 427" type="button" value="+"/> <input data-bbox="975 427 1028 459" type="button" value="-"/> |
| X-Res Technology | Off | Normal | |
| | Soft | Enhance the picture edge. | |
| | Middle | Enhance the picture edge more than the Soft option. | |
| | Hard | Enhance the picture edge more than the Middle option. | |

*1 The availability of each item depends on which item is activated. See page 26 Function Correlation Matrix for more details.

*2 Adjust the Brightness when you are using the monitor in a dark room and feel the screen is too bright.

*3 When Overdrive is activated, some level of image retention will be caused.

Image Settings

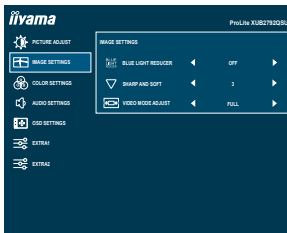

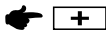
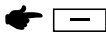
| Adjustment Item | Problem / Option | | Button to Press |
|------------------------|---|---|--|
| Blue Light Reducer *1 | Off | Typical | |
| | Mode 1 | Blue light is reduced. | |
| | Mode 2 | Blue light is reduced more than Mode 1. | |
| | Mode 3 | Blue light is reduced more than Mode 2. | |
| Sharp and Soft | 1 2 3 4 5 6 You can change the picture quality from 1 to 6 (sharp to soft). Press the + Button to change the picture quality in numerical order. Press the – Button to change the picture quality in reverse numerical order. | |   |
| Video Mode Adjust *2,3 | Full | Expansion display | |
| | Aspect | Expansion display of Aspect | |

*1 The availability of each item depends on which item is activated. See page 26 Function Correlation Matrix for more details.

*2 It can display in the center of the screen with a 4:3, 5:4 or 16:10 aspect ratio when input video resolution is 4:3, 5:4 or 16:10.

*3 Disabled when “FreeSync” is activated.



Color Settings

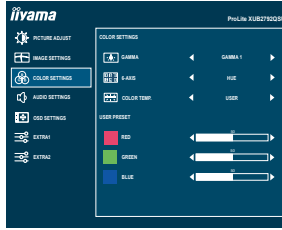

| Adjustment Item | Problem / Option | | Button to Press | |
|------------------|------------------|---------------|------------------------|--|
| Gamma *1 | Gamma1 | Normal | | |
| | Gamma2 | Dark | | |
| | Gamma3 | High contrast | | |
| 6-Axis *1,2 | Hue | Red | Too weak Too strong | <input type="button" value="+"/> <input type="button" value="-"/> |
| | | Yellow | | |
| | | Green | | |
| | | Cyan | | |
| | | Blue | | |
| | Saturation | Red | Too weak Too strong | <input type="button" value="+"/> <input type="button" value="-"/> |
| | | Yellow | | |
| | | Green | | |
| | | Cyan | | |
| | | Blue | | |
| Color Temp. *2,3 | User | Red | Too weak Too strong | <input type="button" value="+"/> <input type="button" value="-"/> |
| | | Green | | |
| | | Blue | | |
| | Warm | Warm color | | |
| | Normal | Normal color | | |
| | Cool | Cool color | | |



*1 Disabled when "i-Style Color" is activated.

*2 Disabled when "Blue Light Reducer" is activated.

*3 Disabled when "Adv. Contrast" is activated.

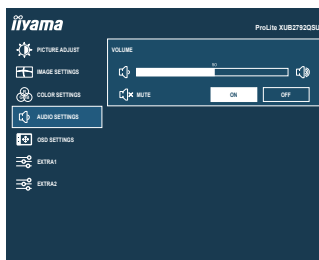
Audio Settings



| Adjustment Item | Problem / Option | | Button to Press |
|--|----------------------|--|--|
| Volume Direct | Too soft Too loud | |  +  - |
| Mute | On | Turn off the sound temporarily. | |
| | Off | Return the sound volume to the previous level. | |
| NOTE Press the + Button to display the volume adjustment bar and switch On and Off the Mute function by pressing the + / – Buttons. | | | |

Direct

You can skip the Menu items and directly display an adjustment scale by using the following button operations.

- Volume : Press the + Button when the Menu is not displayed.

OSD Settings

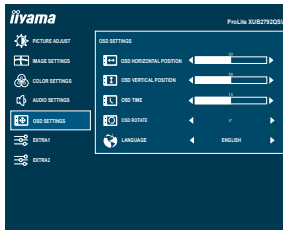

| Adjustment Item | Problem / Option | Button to Press | | |
|-------------------------|--|--|------------|------------|
| OSD Horizontal Position | OSD is too left OSD is too right | <input type="button" value="+"/> <input type="button" value="-"/> | | |
| OSD Vertical Position | OSD is too low OSD is too high | <input type="button" value="+"/> <input type="button" value="-"/> | | |
| OSD Time | You can set the OSD display duration time between 5 and 60 seconds. | <input type="button" value="+"/> <input type="button" value="-"/> | | |
| OSD Rotate * | Rotates the OSD. 0° (Normal) / +90° (Rotate right) / -90° (Rotate left) | <input type="button" value="+"/> <input type="button" value="-"/> | | |
| Language | English | English | Nederlands | Dutch |
| | Deutsch | German | Polski | Polish |
| | Español | Spanish | Português | Portuguese |
| | Français | French | Русский | Russian |
| | Italiano | Italian | Česky | Czech |
| | 日本語 | Japanese | | |

* For ProLite XUB2792QSU

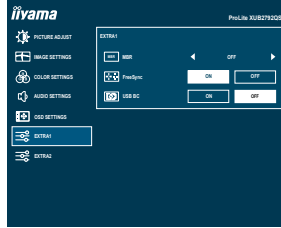

| Adjustment Item | Problem / Option | |
|--|--|--|
| MBR ^{*1,2} | Off / 1 / 2 / 3 / 4 / 5 / 6 / 7 Reduces motion blur on the LCD panel. <div style="float: right;">  <input data-bbox="952 375 1005 406" type="button" value="+"/> <input data-bbox="952 406 1005 438" type="button" value="-"/> </div> | |
| FreeSync ^{*2} | On | Activates the FreeSync function. |
| | Off | The FreeSync function is turned off. |
| USB BC | On | USB devices can be charged even when the monitor is not connected to a working computer with the included USB cable. |
| | Off | USB devices cannot be charged when the monitor is not connected to a working computer with the included USB cable. |
| <div style="background-color: #0056b3; color: white; padding: 5px;">NOTE</div> When the monitor is turned off, USB devices cannot be charged even when the USB BC function is on. | | |

^{*1} Disabled when “FreeSync” is activated. Available when the refresh rate is 75Hz or higher. 100Hz is recommended.

^{*2} The availability of each item depends on which item is activated. See page 26 Function Correlation Matrix for more details.

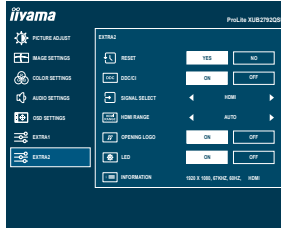

| Adjustment Item | Problem / Option | |
|---|---|---|
| Reset | Yes | Factory-preset data is restored. |
| | No | Return to Menu. |
| DDC/CI | On | DDC/CI is On. |
| | Off | DDC/CI is Off. |
| Signal Select Direct | Auto | Select the signal input automatically. |
| | HDMI | Select the Digital (HDMI) input. |
| | DP | Select the Digital (DisplayPort) input. |
| <p>NOTE If "Auto" is selected, only one source available is selected automatically. If there are more input sources available and you select one of them, the "Auto" option is not available. If multiple inputs are connected, the monitor may not recover the last one used after turning it off and on again. It is only possible when you set a specific source.</p> | | |
| HDMI Range | Full Range | For full-range color scale signal |
| | Limited Range | For limited color scale signal |
| | Auto | Select the HDMI Range automatically. |
| Opening Logo | On | Opening Logo is On. |
| | Off | Opening Logo is Off. |
| LED | On | The Power Indicator is turned On. |
| | Off | The Power Indicator is turned Off. |
| <p>NOTE Turn Off the Power Indicator when you are bothered by the light.</p> | | |
| Information | <p>Displays information regarding the current input signal coming from the graphic card in your computer.</p> <p>NOTE See your graphic card user guide for more information about changing the resolution and refresh.</p> | |

Direct

You can skip the Menu items and directly display an option setting screen by using the following button operations.

- Signal Select: Press the INPUT Button when the Menu is not displayed, it shows following Menu.



- Lock Mode :

<OSD>

Hold the MENU button and turn on the monitor when the monitor is power-off, it will lock/unlock the OSD Lock function.

<Power/OSD>

Pressing and holding the MENU button for 10 seconds when Menu is not displayed, will lock/unlock the Power/OSD Lock function.

■ Function Correlation Matrix

| Item to be selected Item activated | Picture Adjust | | | | | Image Settings | Extra1 | |
|---------------------------------------|----------------|------------|---------------|-----|-----|--------------------|--------|----------|
| | Contrast | Brightness | i-Style Color | ACR | Eco | Blue Light Reducer | MBR | FreeSync |
| i-Style Color | - | - | - | - | - | - | - | - |
| ACR | - | - | - | - | - | - | - | - |
| Eco | ✓ | - | - | - | - | - | - | ✓ |
| Blue Light Reducer | ✓ | ✓ | - | - | - | - | - | ✓ |
| MBR | ✓ | - | ✓ | - | - | - | - | - |
| FreeSync | ✓ | ✓ | - | - | ✓ | ✓ | - | - |

✓ : Available

- : Not available

STANDBY FEATURE

This product features the standby function. When activated, it automatically reduces unnecessary power consumption of the monitor when your computer is not in use.

There is a standby step the monitor takes as described below. The standby function, including any timer settings is configured by the operating system. Check your operating system manual for information on how this can be configured.

■ Standby Mode

When the video signal from the computer is off, the monitor enters into Standby Mode which reduces the power consumption to less than 0.5W*. The screen becomes dark, and the power indicator turns to orange. From Standby Mode, the image reappears in several seconds when either the keyboard or the mouse are touched again.

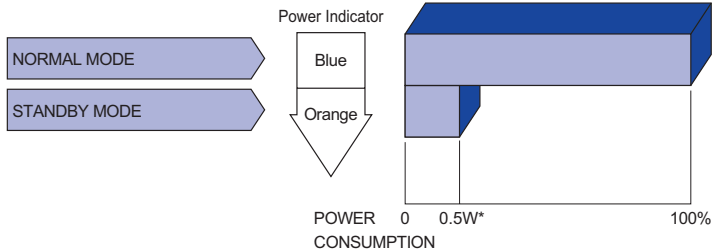

* When the USB devices are not connected.

TROUBLE SHOOTING

If the monitor fails to operate correctly, please follow the steps below for a possible solution.

1. Perform the adjustments described in OPERATING THE MONITOR, depending on the problem you have. If the monitor does not get a picture, skip to 2.
2. Consult the following items if you cannot find an appropriate adjustment item in OPERATING THE MONITOR or if the problem persists.
3. If you are experiencing a problem which is not described below or you cannot correct the problem, discontinue using the monitor and contact your dealer or iiyama service center for further assistance.

| Problem | Check |
|--|---|
| ① The picture does not appear. (Power indicator does not light up.) (Power indicator is blue.) (Power indicator is orange.) | <input type="checkbox"/> The Power Cable is firmly seated in the socket. <input type="checkbox"/> The Power Switch is turned ON. <input type="checkbox"/> The AC socket is live. Please check with another piece of equipment. <input type="checkbox"/> If the blank screen saver is in active mode, touch the keyboard or the mouse. <input type="checkbox"/> Increase the Contrast and/or Brightness. <input type="checkbox"/> The computer is ON. <input type="checkbox"/> The Signal Cable is properly connected. <input type="checkbox"/> The signal timing of the computer is within the specification of the monitor. <input type="checkbox"/> If the monitor is in standby mode, touch the keyboard or the mouse. <input type="checkbox"/> The computer is ON. <input type="checkbox"/> The Signal Cable is properly connected. <input type="checkbox"/> The signal timing of the computer is within the specification of the monitor. |
| ② The screen is not synchronized. | <input type="checkbox"/> The Signal Cable is properly connected. <input type="checkbox"/> The signal timing of the computer is within the specification of the monitor. |
| ③ The screen position is not in the center. | <input type="checkbox"/> The signal timing of the computer is within the specification of the monitor. |
| ④ The screen is too bright or too dark. | <input type="checkbox"/> The video output level of the computer is within the specification of the monitor. |
| ⑤ The screen is shaking. | <input type="checkbox"/> The power voltage is within the specification of the monitor. <input type="checkbox"/> The signal timing of the computer is within the specification of the monitor. |

Problem

Check

- ⑥ No sound.
- The audio equipment (computer etc.) is ON.
 - The Audio Cable is properly connected.
 - The Volume is turned up.
 - The Mute is OFF.
 - The audio output level of the audio equipment is within the specification of the monitor.
- ⑦ The sound is too loud or too quiet.
- The audio output level of the audio equipment is within the specification of the monitor.
- ⑧ A strange noise is heard.
- The Audio Cable is properly connected.

RECYCLING INFORMATION

For better environment protection please don't dispose your monitor.
Please visit our web site: <https://iiyama.com> for monitor recycling.

APPENDIX

Design and specifications are subject to change without prior notice.

SPECIFICATIONS : ProLite XUB2792QSU-B6 / XUB2792QSU-W6

ENGLISH

| | | |
|------------------------------|--|--|
| Size Category | 27" | |
| LCD Panel | Panel technology | IPS (In-Plane-Switching) |
| | Size | Diagonal: 27" (68.5cm) |
| | Pixel pitch | 0.233mm H × 0.233mm V |
| | Brightness | 250cd/m ² (Typical), 155cd/m ² (Default / Energy Saving) |
| | Contrast ratio | 1300 : 1 (Typical), Adv. Contrast Function Available |
| | Viewable angle | Right / Left : 89 degrees each, Up / Down : 89 degrees each (Typical) |
| | MPRT | 0.4ms |
| Display Colors | Approx. 16.7M | |
| Sync Frequency | HDMI(FreeSync: Off): Horizontal: 30.0-147.0kHz, Vertical: 48-100Hz HDMI(FreeSync: On): Horizontal: 30.0-147.0kHz, Vertical: 48-100Hz DisplayPort(FreeSync: Off): Horizontal: 30.0-147.0kHz, Vertical: 48-100Hz DisplayPort(FreeSync: On): Horizontal: 30.0-147.0kHz, Vertical: 48-100Hz | |
| Native Resolution | 2560 × 1440, 3.7 MegaPixels | |
| Support max. resolution | HDMI(FreeSync: Off): 2560 × 1440, 100Hz HDMI(FreeSync: On): 2560 × 1440, 100Hz DisplayPort(FreeSync: Off): 2560 × 1440, 100Hz DisplayPort(FreeSync: On): 2560 × 1440, 100Hz | |
| Input Connector | HDMI, DisplayPort | |
| Input Video Signal | HDMI, DisplayPort | |
| USB Standard | USB3.2 Gen 1 (5Gbps, DC5V, 900mA) | |
| Number of USB Ports | 1 Upstream : Series B | |
| Connector shape | 4 Downstream : Series A | |
| Headphone Connector *1 | ø 3.5mm mini jack (Stereo) | |
| Speakers | 2W × 2 (Stereo speakers) | |
| Maximum Screen Size | 596.7mm W × 335.7mm H / 23.5" W × 13.2" H | |
| Power Source | 100-240VAC, 50/60Hz, 1.5A | |
| Power Consumption *2 | 25W typical, 22W (Default / Energy Saving) Standby mode: 0.5W maximum, Off mode: 0.3W maximum | |
| Dimensions / Net Weight | 613.0 × 394.5 - 544.5 × 209.5mm / 24.1 × 15.5 - 21.4 × 8.3" (W×H×D) 6.1kg / 13.5lbs | |
| Height Adjustment Range | 150mm | |
| Angle | Tilt: Upward: 22 degrees, Downward: 5 degrees Swivel: Left / Right: 45 degrees each Rotation: Clockwise / Counterclockwise: 90 degrees each | |
| Environmental Considerations | Operating: Temperature 5 to 35°C / 41 to 95°F Humidity 10 to 80% (No condensation) Storage: Temperature -20 to 60°C / -4 to 140°F Humidity 10 to 90% (No condensation) | |
| EPEAT Bronze | Visit www.epeat.net for the registration status in your country | |
| Approvals | TCO Certified, CE, UKCA, TÜV-Bauart, VCCI, PSE, EAC | |

NOTE

*1 Proper operation of connected external devices other than headphones is not guaranteed.

*2 When the USB devices are not connected.

SPECIFICATIONS : ProLite XU2792QSU-B6

| | | |
|------------------------------|--|--|
| Size Category | 27" | |
| LCD Panel | Panel technology | IPS (In-Plane-Switching) |
| | Size | Diagonal: 27" (68.5cm) |
| | Pixel pitch | 0.233mm H × 0.233mm V |
| | Brightness | 250cd/m ² (Typical), 155cd/m ² (Default / Energy Saving) |
| | Contrast ratio | 1300 : 1 (Typical), Adv. Contrast Function Available |
| | Viewable angle | Right / Left : 89 degrees each, Up / Down : 89 degrees each (Typical) |
| | MPRT | 0.4ms |
| Display Colors | Approx. 16.7M | |
| Sync Frequency | HDMI(FreeSync: Off): Horizontal: 30.0-147.0kHz, Vertical: 48-100Hz HDMI(FreeSync: On): Horizontal: 30.0-147.0kHz, Vertical: 48-100Hz DisplayPort(FreeSync: Off): Horizontal: 30.0-147.0kHz, Vertical: 48-100Hz DisplayPort(FreeSync: On): Horizontal: 30.0-147.0kHz, Vertical: 48-100Hz | |
| Native Resolution | 2560 × 1440, 3.7 MegaPixels | |
| Support max. resolution | HDMI(FreeSync: Off): 2560 × 1440, 100Hz HDMI(FreeSync: On): 2560 × 1440, 100Hz DisplayPort(FreeSync: Off): 2560 × 1440, 100Hz DisplayPort(FreeSync: On): 2560 × 1440, 100Hz | |
| Input Connector | HDMI, DisplayPort | |
| Input Video Signal | HDMI, DisplayPort | |
| USB Standard | USB3.2 Gen 1 (5Gbps, DC5V, 900mA) | |
| Number of USB Ports | 1 Upstream : Series B | |
| Connector shape | 4 Downstream : Series A | |
| Headphone Connector *1 | ø 3.5mm mini jack (Stereo) | |
| Speakers | 2W × 2 (Stereo speakers) | |
| Maximum Screen Size | 596.7mm W × 335.7mm H / 23.5" W × 13.2" H | |
| Power Source | 100-240VAC, 50/60Hz, 1.5A | |
| Power Consumption *2 | 25W typical, 22W (Default / Energy Saving) Standby mode: 0.5W maximum, Off mode: 0.3W maximum | |
| Dimensions / Net Weight | 613.0 × 432.0 × 199.5mm / 24.1 × 17.0 × 7.9" (W×H×D) 4.6kg / 10.1lbs | |
| Tilt Angle | Upward: 21.5 degrees Downward: 3.5 degrees | |
| Environmental Considerations | Operating: Temperature 5 to 35°C / 41 to 95°F Humidity 10 to 80% (No condensation) Storage: Temperature -20 to 60°C / -4 to 140°F Humidity 10 to 90% (No condensation) | |
| EPEAT Bronze | Visit www.epeat.net for the registration status in your country | |
| Approvals | TCO Certified, CE, UKCA, TÜV-Bauart, VCCI, PSE, EAC | |

NOTE

*1 Proper operation of connected external devices other than headphones is not guaranteed.

*2 When the USB devices are not connected.

DIMENSIONS : ProLite XUB2792QSU

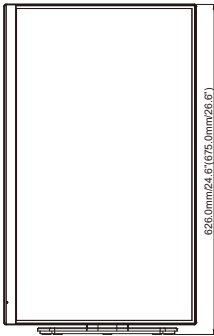
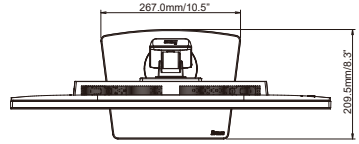
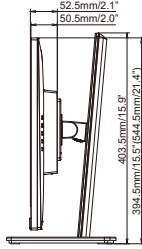
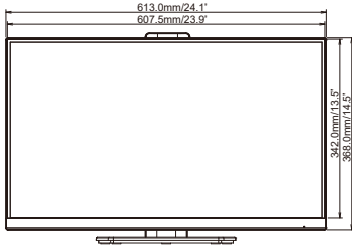

() : Maximum adjustment range

DIMENSIONS : ProLite XU2792QSU

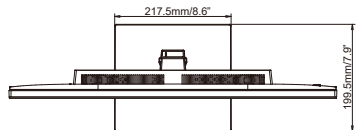
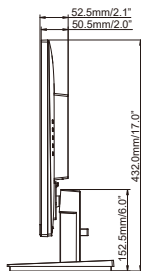
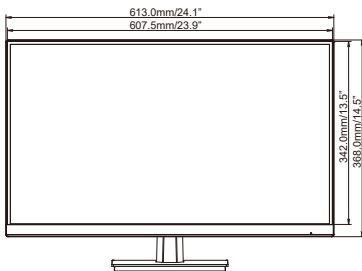

COMPLIANT TIMING

| Video Mode | Horizontal Frequency | Vertical Frequency | Dot Clock |
|-------------|----------------------|--------------------|------------|
| 800 × 600 | 37.879kHz | 60.317Hz | 40.000MHz |
| | 46.875kHz | 75.000Hz | 49.500MHz |
| 1024 × 768 | 48.363kHz | 60.004Hz | 65.000MHz |
| | 60.023kHz | 75.029Hz | 78.750MHz |
| 1280 × 1024 | 63.981kHz | 60.020Hz | 108.000MHz |
| | 79.976kHz | 75.025Hz | 135.000MHz |
| 1680 × 1050 | 65.290kHz | 60.000Hz | 146.250MHz |
| 1920 × 1080 | 67.500kHz | 60.000Hz | 148.500MHz |
| 2560 × 1440 | 88.860kHz | 60.000Hz | 241.699MHz |
| | 111.900kHz | 75.000Hz | 304.368MHz |
| | 127.420kHz | 85.000Hz | 346.569MHz |
| | 146.400kHz | 100.000Hz | 401.136MHz |