

USER MANUAL

ProLite

LCD Monitor

ENGLISH

ProLite TH5563MTS
ProLite TH5563MIS
ProLite LH5563S

Thank you very much for choosing the iiyama LCD monitor.

We recommend that you take a few minutes to read this comprehensive manual carefully before installing and switching on the monitor. Please keep this manual in a safe place for your future reference.



Dear user, we congratulate you on the purchase of your iiyama LCD.

For details on warranty and locally used pixel policies that apply directly after installation of your product please check the iiyama website.

To report a fault, please contact your local support centre found at www.iiyama.com/service

Things to check before you call the iiyama information line

- | if the power cable is connected securely and turned on?
- | if the display has been turned on?
- | if the signal cable is connected securely and the correct input selected?
- | if the computer has been restarted with the display connected?
- | if the graphics card is correctly installed with the latest drivers possible?
- | if the correct native resolution has been selected via 'Display Properties'?
- | If the R/G/B signal configuration is correct?
- | if the displays On Screen Menu is shown?
- | if the correct brightness and contrast settings have been set?
- | if given display tolerances and compatibility have been considered?
- | if via the On Screen Menu you have performed a Factory Reset/Recall?

Before reporting the screen defect, please prepare the following information/evidence:

- | model number *
- | purchase receipt and serial number *
- | name and address for collection
- | telephone/fax number, for availability during the day
- | convenient collection date (date, time)
- | short description of the defect

Important Note:

If there is no fault found in the collected equipment after inspection, the transferring party shall incur charges for transport and administration.

If you have checked all of the above and there is still no picture, call our information line for assistance in your country.

* see the identification plate on the back of the case.

CE MARKING DECLARATION OF CONFORMITY

This LCD monitor complies with the requirements of the EC/EU Directive 2004/108/EC "EMC Directive", 2006/95/EC "Low Voltage Directive" and 2011/65/EU "RoHS Directive".

Warning

This is a class A product. In a domestic environment this product may cause radio interference in which case the user may be required to take adequate measures.

IYYAMA CORPORATION: Wijkemeerstraat 8, 2131 HA Hoofddorp, The Netherlands



We recommend recycling of used product. Please contact your dealer or iiyama service center. Recycle information is obtained via the Internet, using the address: <http://www.iiyama.com>

You can access the Web page of different countries from there.

- We reserve the right to change specifications without notice.
- All trademarks used in this user manual are the property of their respective owners.

TABLE OF CONTENTS

FOR YOUR SAFETY.....	1
SAFETY PRECAUTIONS.....	1
SPECIAL NOTES ON LCD MONITORS	3
CUSTOMER SERVICE	4
CLEANING	4
BEFORE YOU OPERATE THE MONITOR	5
FEATURES.....	5
CHECKING THE CONTENTS OF THE PACKAGE	5
UNPACKING	6
SPECIAL NOTES ON : ProLite TH5563MTS / ProLite TH5563MIS ..	6
CONTROLS AND CONNECTORS : MONITOR.....	7
INSTALLATION	10
CONTROLS AND CONNECTORS : REMOTE CONTROL.....	12
PREPARING THE REMOTE CONTROL.....	13
BASIC OPERATION.....	14
CONNECTING YOUR MONITOR : ProLite TH5563MTS	17
CONNECTING YOUR MONITOR : ProLite TH5563MIS	18
CONNECTING YOUR MONITOR : ProLite LH5563S.....	19
COMPUTER SETTING	21
OPERATING THE MONITOR.....	22
ADJUSTMENT MENU CONTENTS.....	24
SCREEN ADJUSTMENTS	30
POWER MANAGEMENT FEATURE.....	33
TROUBLE SHOOTING	34
RECYCLING INFORMATION.....	35
APPENDIX	36
SPECIFICATIONS : ProLite TH5563MTS	36
SPECIFICATIONS : ProLite TH5563MIS	37
SPECIFICATIONS : ProLite LH5563S	38
DIMENSIONS.....	39
COMPLIANT TIMING	41
PIP SUPPORT SCREEN TABLE	42

FOR YOUR SAFETY

SAFETY PRECAUTIONS

WARNING

STOP OPERATING THE MONITOR WHEN YOU SENSE TROUBLE

If you notice any abnormal phenomena such as smoke, strange sounds or fumes, unplug the monitor and contact your dealer or iiyama service center immediately. Further use may be dangerous and can cause fire or electric shock.

NEVER REMOVE THE CABINET

High voltage circuits are inside the monitor. Removing the cabinet may expose you to the danger of fire or electric shock.

DO NOT PUT ANY OBJECT INTO THE MONITOR

Do not put any solid objects or liquids such as water into the monitor. In case of an accident, unplug your monitor immediately and contact your dealer or iiyama service center. Using the monitor with any object inside may cause fire, electric shock or damage.

INSTALL THE MONITOR ON A FLAT, STABLE SURFACE

The monitor may cause an injury if it falls or is dropped.

DO NOT USE THE MONITOR NEAR WATER

Do not use where water may be splashed or spilt onto the monitor as it may cause fire or electric shock.

OPERATE UNDER THE SPECIFIED POWER SUPPLY

Be sure to operate the monitor only with the specified power supply. Use of an incorrect voltage will cause malfunction and may cause fire or electric shock.

PROTECT THE CABLES

Do not pull or bend the power cable and signal cable. Do not place the monitor or any other heavy objects on the cables. If damaged, the cables may cause fire or electric shock.

ADVERSE WEATHER CONDITIONS

It is advisable not to operate the monitor during a heavy thunder storm as the continual breaks in power may cause malfunction. It is also advised not to touch the plug in these circumstances as it may cause electric shock.

CAUTION

INSTALLATION LOCATION

Do not install the monitor where sudden temperature changes may occur, or in humid, dusty or smoky areas as it may cause fire, electric shock or damage. You should also avoid areas where the sun shines directly on the monitor.

DO NOT PLACE THE MONITOR IN A HAZARDOUS POSITION

The monitor may topple and cause injury if not suitably located. Please also ensure that you do not place any heavy objects on the monitor, and that all cables are routed such that children may not pull the cables and possibly cause injury.

MAINTAIN GOOD VENTILATION

Ventilation slots are provided to keep the monitor from overheating. Covering the slots may cause fire. To allow adequate air circulation, place the monitor at least 10 cm (or 4 inches) from any walls.

Do not remove the tilt stand when operating the monitor. Ventilation slots on the back of the cabinet will be blocked and the monitor may overheat if the stand is removed. This may cause fire or damage. Operating the monitor on its back, side, upside down or on a carpet or any other soft material may also cause damage.

DISCONNECT THE CABLES WHEN YOU MOVE THE MONITOR

When you move the monitor, turn off the power switch, unplug the monitor and be sure the signal cable is disconnected. If you do not disconnect them, it may cause fire or electric shock.

UNPLUG THE MONITOR

If the monitor is not in use for a long period of time it is recommended that it is left unplugged to avoid accidents.

HOLD THE PLUG WHEN DISCONNECTING

To disconnect the power cable or signal cable, always pull it by the plug. Never pull on the cable itself as this may cause fire or electric shock.

DO NOT TOUCH THE PLUG WITH WET HANDS

Pulling or inserting the plug with wet hands may cause electric shock.

WHEN YOU INSTALL THE MONITOR ON YOUR COMPUTER

Be sure the computer is strong enough to hold the weight of the monitor, otherwise, you may damage your computer.

DO NOT USE THE MONITOR FOR 24-HOURS CONTINUOUSLY

The monitor is not designed to work for 24-hours continuously, do not use the monitor for 24-hours continuously.

OTHERS

ERGONOMIC RECOMMENDATIONS

To eliminate eye fatigue, do not operate the monitor against a bright background or in a dark room. For optimal viewing comfort, the monitor should be just below eye level and 40-60 cm (16-24 inches) away from your eyes. When using the monitor over a prolonged time, a ten minute break every hour is recommended as looking at the screen continuously can cause eye strain.

SPECIAL NOTES ON LCD MONITORS

The following symptoms are normal with LCD monitors and do not indicate a problem.

NOTE

- When you first turn on the LCD monitor, the picture may not fit in the display area because of the type of computer that is used. In this case, adjust the picture position to the correct position.
- Due to the nature of the backlight, the screen may flicker during initial use. Turn off the Power Switch and then turn it on again to make sure the flicker disappears.
- You may find slightly uneven brightness on the screen depending on the desktop pattern you use.
- Due to the nature of the LCD screen, an afterimage of the previous screen may remain after switching the image, when the same image is displayed for hours. In this case, the screen is recovered slowly by changing the image or turning off the Power Switch for hours.
- Contact your dealer or iiyama service center for the backlight replacement when the screen is dark, flickering or not lighting up. Never attempt to replace it by yourself.
- Max. non-stop operating time and conditions
 - (1) If a static image is displayed continuously, it is recommended to disrupt it with a motion picture.
 - (2) It is recommended to periodically change the background colour and background image.
 - (3) Maximum operating time of the display is 18 hours per day, if the IRFM function is set on. If the IRFM function is off, do not exceed a 12 hour non-stop operating time limit.
 - (4) If the screen is active for a longer period of time, it is recommended to
 - I. Run the screensaver (motion picture or black pattern)
 - II. Power off the system for a while
 - (5) Make sure that the screen is suitably ventilated, or is used in conjunction with climate control system if installed into any bespoke cabinets.
 - (6) We strongly recommend an active cooling system with fans for long operating times, especially for high luminance LCD models.
- This LCD cannot be used outdoors.
- This LCD cannot be used with the screen facing upwards.
- If you use a cable longer than the supplied one, the picture quality is not guaranteed. Touch function can be disrupted if the USB cable length exceeds 3m.

CUSTOMER SERVICE

NOTE

- The fluorescent light used in the LCD monitor may have to be periodically replaced. For the warranty coverage on this component, please check with local iiyama service center.
- If you have to return your unit for service and the original packaging has been discarded, please contact your dealer or iiyama service center for advice or replacement packaging.

CLEANING

WARNING

- If you drop any materials or liquids such as water into the monitor when cleaning, unplug the power cable immediately and contact your dealer or iiyama service center.

CAUTION

- For safety reasons, turn off the power switch and unplug the monitor before you clean it.

NOTE

- To protect the LCD panel, do not scratch or rub the screen with a hard object.
- Never use any of the following strong solvents. These will damage the cabinet and the LCD screen.

Thinner	Benzine	Abrasive cleaner
Spray-type cleaner	Wax	Acid or Alkaline solvent

- Touching the cabinet with any product made from rubber or plastic for a long time may cause degeneration or loss of paint on the cabinet.

CABINET

Stains can be removed with a cloth lightly moistened with a mild detergent solvent. Then wipe the cabinet with a soft dry cloth.

LCD

Periodic cleaning with a soft dry cloth is recommended.

SCREEN

Don't use tissue paper etc. because these will damage the LCD screen.

BEFORE YOU OPERATE THE MONITOR

FEATURES

- ◆ Supports Resolutions up to 1920 × 1080
- ◆ High Contrast 1300:1 (Typical) / Brightness 450cd/m² (Typical)
- ◆ Digital Character Smoothing
- ◆ Automatic Set-up
- ◆ Stereo Speakers
2 × 10W Stereo Speakers
- ◆ Plug & Play VESA DDC2B Compliant
Windows[®] XP/Vista/7 Compliant
- ◆ Power Management (VESA DPMS Compliant)
- ◆ VESA Mounting Standard (200mm×400mm) Compliant

CHECKING THE CONTENTS OF THE PACKAGE

The following accessories are included in your package. Check to see if they are enclosed with the monitor. If anything is missing or damaged, please contact your local iiyama dealer or regional iiyama office.

- | | | |
|-----------------------------|---------------------------|-----------------------|
| ■ Power Cable* ¹ | ■ D-Sub Signal Cable | ■ DVI-D Signal Cable |
| ■ Remote Control | ■ Touch Pen* ² | ■ iiyama Logo Sticker |
| ■ Safety Guide | ■ Quick Start Guide | |

CAUTION *¹ The rating of the Power Cable enclosed in 120V area is 10A/125V. If you are using a power supply higher than this rating, then a power cable with a rating of 10A/250V must be used. However, all guarantees and warranties are void for any problems or damage caused by a power cable not supplied by iiyama.

*² Accessory for ProLite TH5563MTS / ProLite TH5563MIS.

UNPACKING

- ① Before unpacking your monitor, prepare a stable, level, and clean surface near a wall outlet. Set the LCD Monitor box in an upright position and open from the top of the box before removing the top cushions.
- ② Remove the carton holders.
- ③ Remove the top cushion and take the accessories box and the Monitor out.

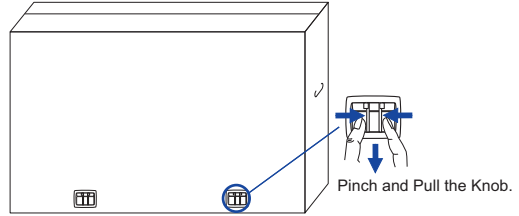

CAUTION

Moving the monitor requires at least two people. If not, it may drop and could result in a serious injury.

When moving/shipping the monitor, please hold by the carton holders.



SPECIAL NOTES ON : ProLite TH5563MTS / ProLite TH5563MIS

CAUTION

Permanent damage can occur if Sharp Edged, Pointed or Metal items are used to activate Touch. This could invalidate any remaining warranty.

We recommend you use a plastic stylus (tip R0.8 or over) or finger.

CONTROLS AND CONNECTORS : MONITOR

<Back Controller>

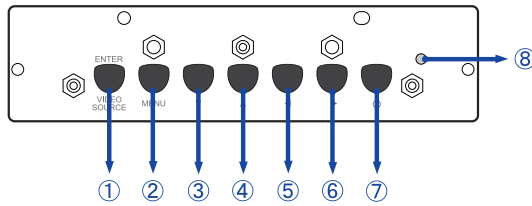

①	ENTER/SOURCE	Enter/Input Select Button
②	MENU	Menu Button
③	▼	Down Button
④	▲	Up Button
⑤	◀	Left Button
⑥	▶	Right Button
⑦	⏻	Power Button

<Front>

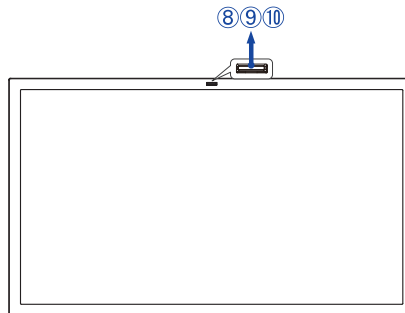

⑧	Power Indicator	Green	Normal Operation
		Red	Flash : Power Management Lighting : If turn off the Power Button on the Remote Control and the Back Controller.
		Off	Power Off If turn off the Main Power Switch.
⑨	Remote Sensor	Remote Sensor	
⑩	Ambient Light Sensor	Detects ambient lighting conditions around the Monitor and adjusts screen brightness automatically when the Ambient Light Sensor function is activated.	

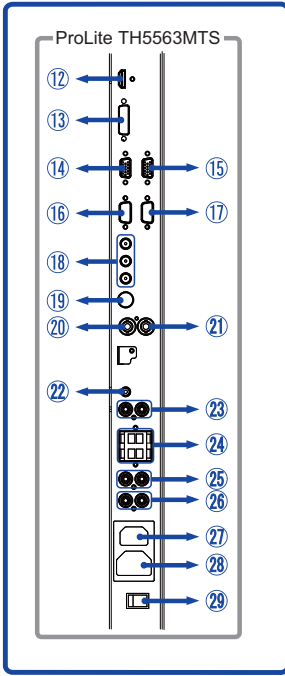

<Back : ProLite TH5563MTS>

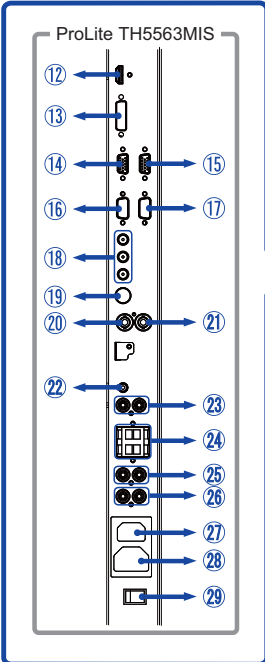
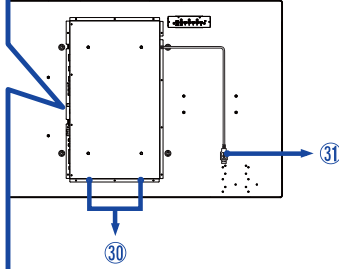

<Back : ProLite TH5563MIS>

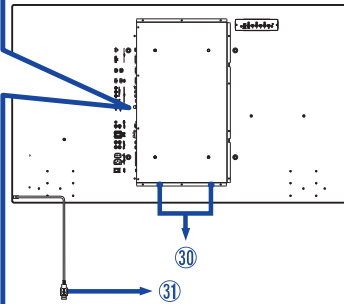

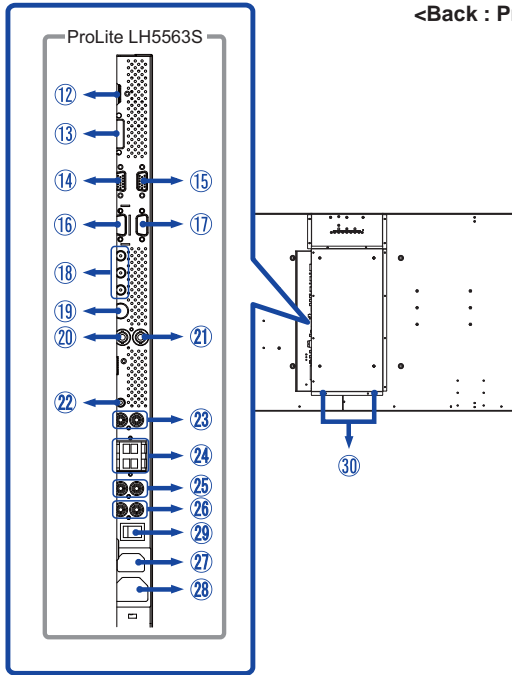

⑫	HDMI	HDMI	HDMI Connector
⑬	DVI	DVI-D 24pin	DVI-D 24pin Connector
⑭	VGA IN	D-SUB mini 15pin	D-SUB mini 15pin Connector
⑮	VGA OUT	D-SUB mini 15pin	D-SUB mini 15pin Connector
⑯	RS232C IN	D-SUB 9pin	RS232C Connector
⑰	RS232C OUT	D-SUB 9pin	RS232C Connector
⑱	COMPONENT VIDEO	RCA G/B/R	Component Video Connector
⑲	S-VIDEO	Mini Din 4pin	S-Video Connector
⑳	VIDEO IN	RCA	Video Connector
㉑	VIDEO OUT	RCA	Video Connector
㉒	AUDIO1 (PC Audio In)	Mini Jack	Audio Connector
㉓	AUDIO OUT	RCA L/R	Audio output Connector
㉔	SPEAKERS	Jack	Speakers Connector
㉕	AUDIO2	RCA L/R	Audio Connector
㉖	AUDIO3	RCA L/R	Audio Connector
㉗	AC IN	AC-INLET	AC Connector (AC-IN)
㉘	AC OUT	AC-OUTLET	AC Connector (AC-OUT)
㉙	— (ON) / ○ (OFF)	MAIN POWER	Main Power Switch
⑳	Speakers		Speakers
㉑	USB Cable*		Touch USB Cable

* Available for ProLite TH5563MTS / ProLite TH5563MIS only.

INSTALLATION

CAUTION

- Follow the manual instructions for the type of mount you have selected. Refer all servicing to qualified service personnel.
- Moving the monitor requires at least two people.
- Before installing, please make sure the wall is strong enough to hold the necessary weight of the display and the mount.

[WALL MOUNTING]

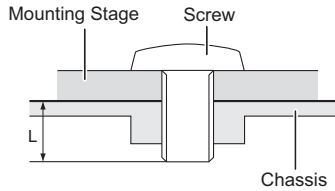

CAUTION

When using the wall mounting, consideration of thickness of the mounting stage needs to be taken. Tighten the M8 Screw with washer which "L" length is 10mm to fasten the monitor. Using a screw longer than this may cause electric shock or damage because it may contact with the electrical parts inside the monitor.

[INSTALLATION NOTE] *Available for ProLite TH5563MTS / ProLite TH5563MIS only.

The touch kit of this monitor is an optical device that utilizes infrared light source and sensitive sensors for touch detection.

Notice the incident light that contains large quantities of infrared light may affect touch screen operation and performance.

Please install it with care as follows to ensure reliable touch performance.

Intense light / Specular light / Focus spotlight / Wide spread light / Direct sunlight / Indirect sunlight from the window and/or the glass door. / Not install the touch monitor right under the light source.

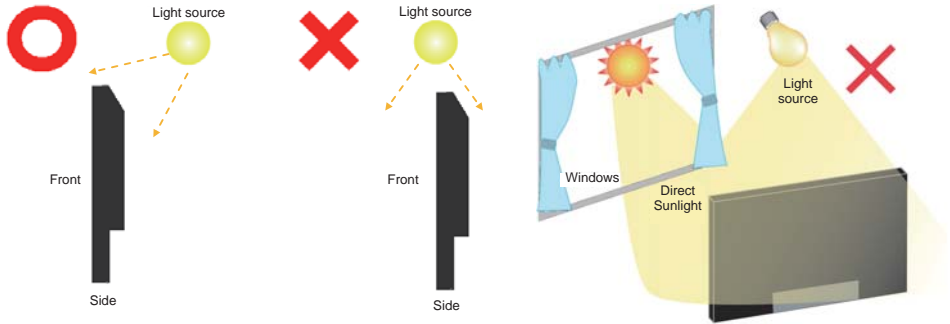

[ROTATING THE DISPLAY]

●ProLite TH5563MTS

It is designed to be compatible in landscape modes.

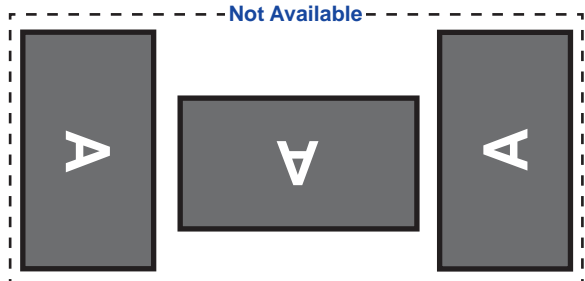
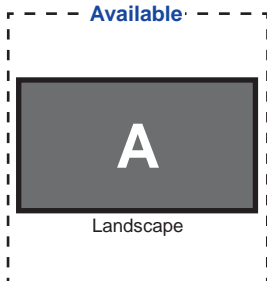

●ProLite LH5563S / ProLite TH5563MIS

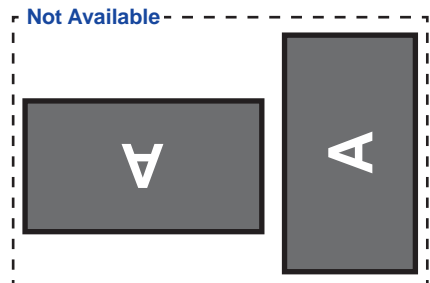
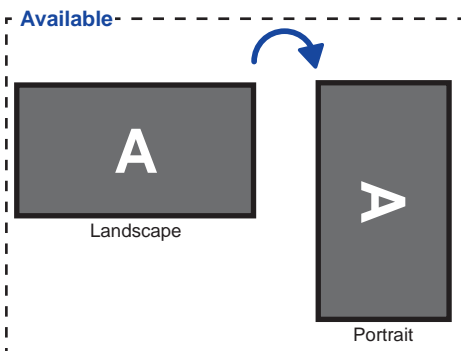

It is designed to be compatible in both landscape and portrait modes, however, it is optimized for landscape mode.

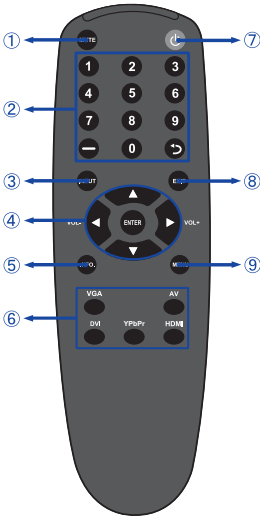

CONTROLS AND CONNECTORS : REMOTE CONTROL

ENGLISH



①	MUTE	Turns off the sound.
②	Not available on this model.	
③	INPUT	Selects the source.
④		Navigates through submenus and settings. ▲: Up Button ▼: Down Button ◀: Left Button ▶: Right Button ◀ (Volume-): Decreases the sound volume. ▶ (Volume+): Increases the sound volume.
	ENTER	Confirms your selection or save changes.
⑤	INFO	Provides source and resolution information.
⑥	VGA / DVI / YPbPr / AV / HDMI	Selects the source.
⑦		Turns the monitor ON and OFF.
⑧	EXIT	Returns to a previous menu or closes the OSD Menu.
⑨	MENU	Opens the monitor's on-screen menu systems. When the menu system is already open, pressing this button will select the previous submenu.

PREPARING THE REMOTE CONTROL

To use the remote control, insert the two dry batteries.

CAUTION

Do not use any other batteries other than those specified in this manual for the Remote Control. Do not insert old and new batteries together in the Remote Control. Make sure that the terminals match the "+" and "-" indications in the battery compartment. Burst batteries or the electrolyte from these batteries may cause stains, fire or injury.

- ① Slide back and remove the battery cover in the direction of the arrow.

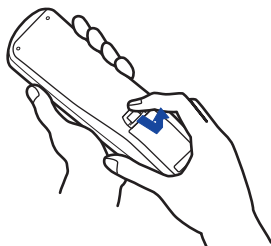

- ② Align and insert two AAA batteries according to their plus and minus ports (as indicated in the remote control).

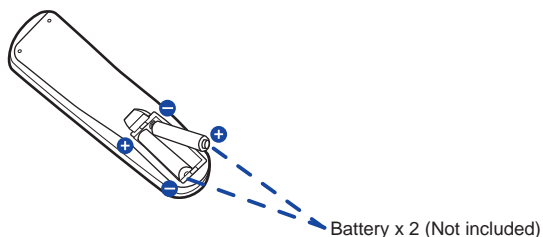

- ③ Replace the battery cover in the direction of the arrow and snap it back into place.

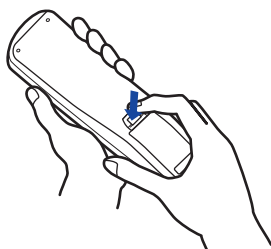

NOTE

- Replace with new batteries when the Remote Control does not work close to the monitor. Use AAA dry batteries.
- Operate the Remote Control by pointing it toward the Remote Sensor on the monitor.
- Other manufacturers remote control will not work with this monitor. Use the provided Remote Control ONLY.
- Used batteries needed to follow the city rule to be discarded. (suggestion: to dispose of used batteries please follow correct policy as per your council regulations)

BASIC OPERATION

■ Turning the monitor ON

The monitor is turned On and the Power Indicator turns to Blue when you press the Power Button on the monitor or the Remote Control. The monitor is turned Off and the Power Indicator turns to orange when you press the Power Button on the monitor or the Remote Control.

Press again to turn On the monitor.

NOTE

Even when using the power management mode or turning OFF the Power Switch, the monitor will consume a small amount of electricity. Disconnect the Power Cable from the power supply whenever the monitor is not in use or during the night, to avoid unnecessary power consumption.

[Monitor]

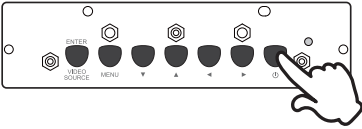

[Remote Control]



■ Display the adjustment menu page

The menu page appears on the screen when you press the MENU Button on the monitor or the Remote Control.

The menu page disappears when you press the EXIT Button on the Remote Control again.

[Monitor]

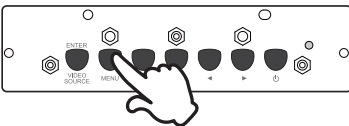

[Remote Control]



■ Move the cursor vertically

Select adjustment by pressing the ▲ / ▼ Button while the menu page is displayed on the screen.

[Monitor]

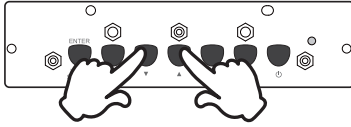

[Remote Control]

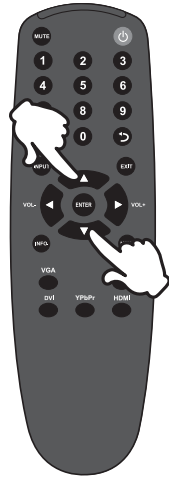

■ Move the cursor horizontally

Select menu or setting, or perform the adjustment by pressing the ◀ / ▶ Button while the menu page is displayed on the screen.

[Monitor]



[Remote Control]

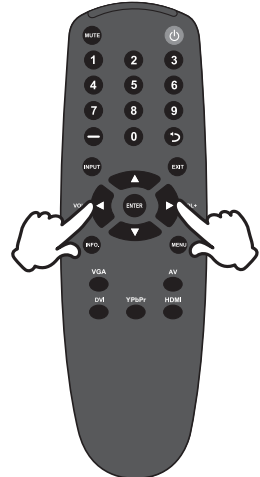

■ Adjust the volume of sound

Press the ◀/▶ Button on the Remote Control to adjust the volume of sound when the menu page is not displayed on the screen.

[Remote Control]

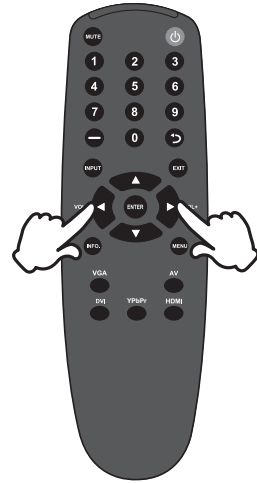

■ Switch the input signal

This is activated when you successively press the Source Button on the monitor or Input Signal Button on the Remote Control as follows:

[Monitor]



[Remote Control]



CONNECTING YOUR MONITOR : ProLite TH5563MTS

- ① Ensure that both the computer and the monitor are switched off.
- ② Connect the computer to the monitor with the signal cable.
- ③ Connect the computer with the USB cable from the monitor.
- ④ Connect the Power cable to the monitor first and then to the power supply.
- ⑤ Turn on your monitor (Main Power Switch and Power Switch) and computer.

- NOTE**
- The signal cables used for connecting the computer and monitor may vary with the type of computer used. An incorrect connection may cause serious damage to both the monitor and the computer. The cable supplied with the monitor is for a standard 15 pin D-Sub connector. If a special cable is required please contact your local iiyama dealer or regional iiyama office.
 - For connection to Macintosh computers, contact your local iiyama dealer or regional iiyama office for a suitable adaptor.
 - Make sure you tighten the finger screws at each end of the Signal.
 - Don't connect the RS-232C cable and the USB cable to the computer at the same time. And cannot use those at the same time.

[Example of Connection]

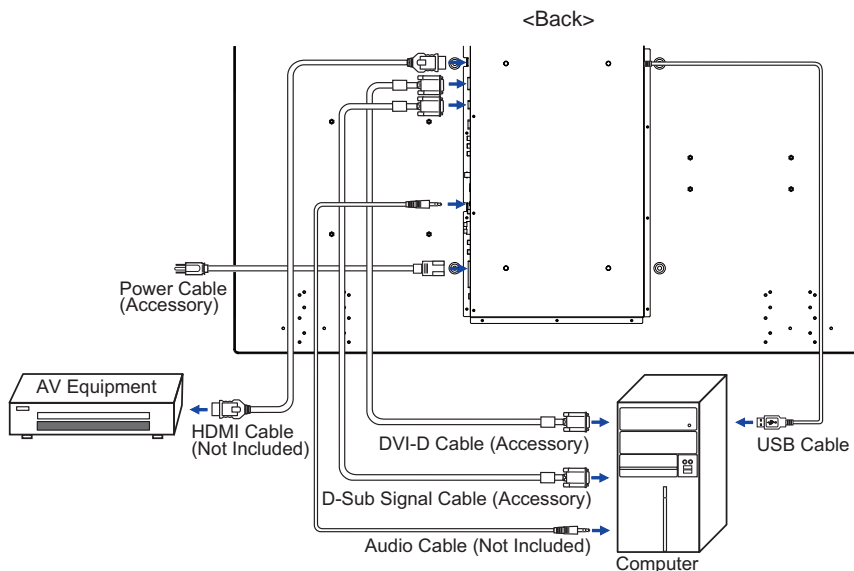

CONNECTING YOUR MONITOR : ProLite TH5563MIS

- ① Ensure that both the computer and the monitor are switched off.
- ② Connect the computer to the monitor with the signal cable.
- ③ Connect the computer with the USB cable from the monitor.
- ④ Connect the Power cable to the monitor first and then to the power supply.
- ⑤ Turn on your monitor (Main Power Switch and Power Switch) and computer.

NOTE

- The signal cables used for connecting the computer and monitor may vary with the type of computer used. An incorrect connection may cause serious damage to both the monitor and the computer. The cable supplied with the monitor is for a standard 15 pin D-Sub connector. If a special cable is required please contact your local iiyama dealer or regional iiyama office.
- For connection to Macintosh computers, contact your local iiyama dealer or regional iiyama office for a suitable adaptor.
- Make sure you tighten the finger screws at each end of the Signal.
- Don't connect the RS-232C cable and the USB cable to the computer at the same time. And cannot use those at the same time.

[Example of Connection]

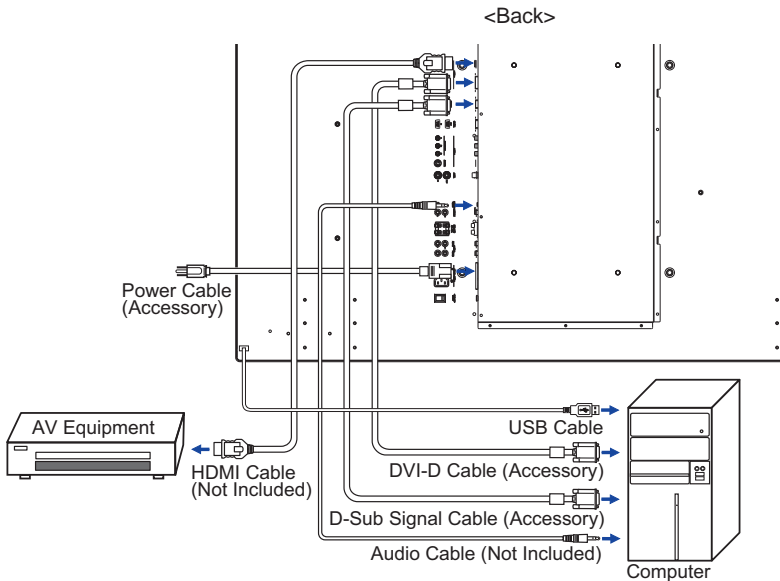

CONNECTING YOUR MONITOR : ProLite LH5563S

- ① Ensure that both the computer and the monitor are switched off.
- ② Connect the computer to the monitor with the signal cable.
- ③ Connect the Power cable to the monitor first and then to the power supply.
- ④ Turn on your monitor (Main Power Switch and Power Switch) and computer.

- NOTE**
- The signal cables used for connecting the computer and monitor may vary with the type of computer used. An incorrect connection may cause serious damage to both the monitor and the computer. The cable supplied with the monitor is for a standard 15 pin D-Sub connector. If a special cable is required please contact your local iiyama dealer or regional iiyama office.
 - For connection to Macintosh computers, contact your local iiyama dealer or regional iiyama office for a suitable adaptor.
 - Make sure you tighten the finger screws at each end of the Signal.

[Example of Connection]

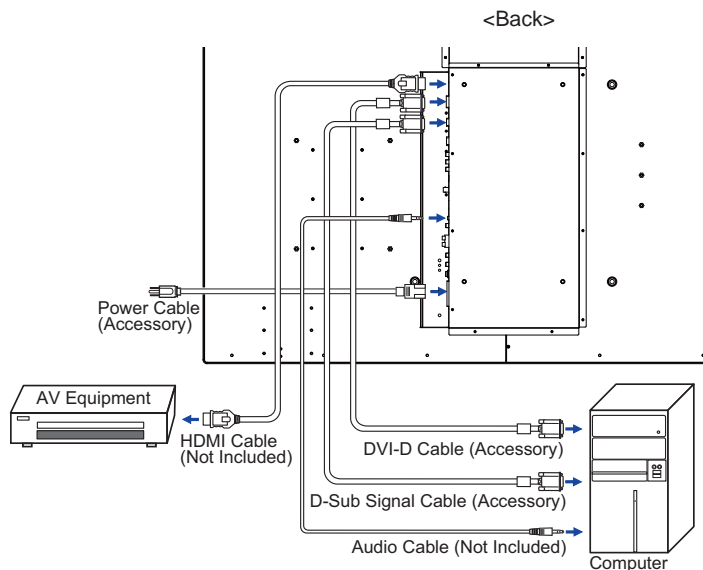

[Connection example with the peripheral device]

CAUTION

Turn off the power switch and unplug the monitor and peripherals before connection to avoid electric shock or damage.

NOTE

- Refer to the user manual of peripherals at the same time.
- Ensure you have the necessary cables as required.

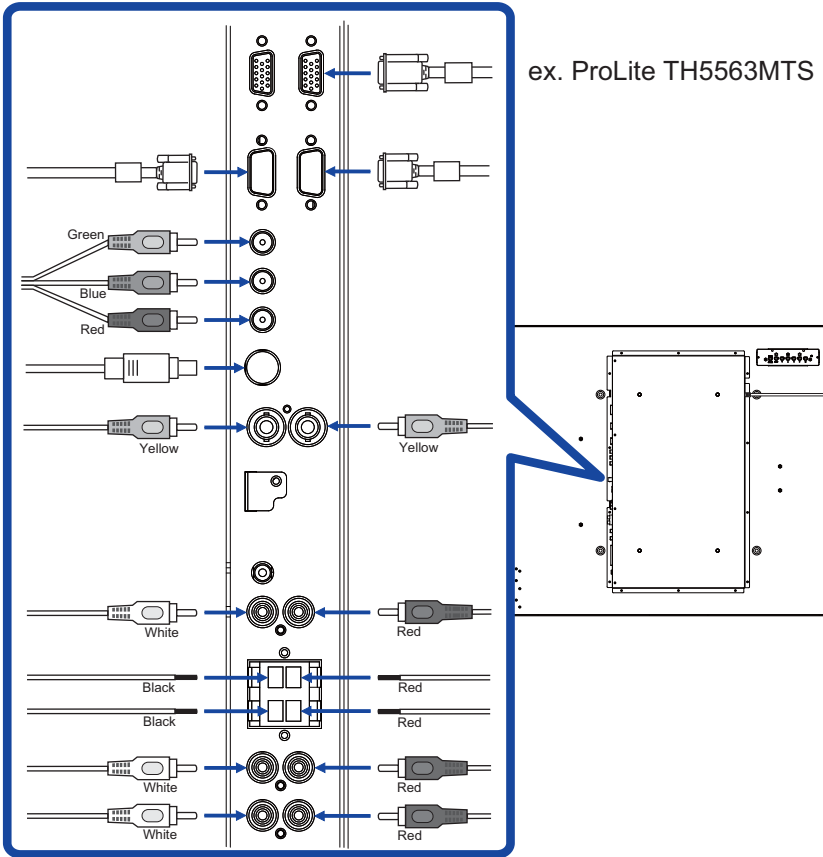

COMPUTER SETTING

■ Signal Timing

Change to the desired signal timing listed on page 41: COMPLIANT TIMING.

■ Procedure for turning ON the Power Switch

Turn ON the monitor first, and then the computer.

■ MULTI-TOUCH : ProLite TH5563MTS / ProLite TH5563MIS

This monitor complies with DDC2B of VESA standard. (Plug&play compliant)

The MULTI-TOUCH function runs on Windows7 by connecting the monitor to DDC2B compliant computer with the USB cable supplied.

■ MULTI-TOUCH support operation system : ProLite TH5563MTS / ProLite TH5563MIS

Microsoft Windows XP (64 bit and 32 bit)

Microsoft Windows Vista (64 bit and 32 bit)

Microsoft Windows 7 (64 bit and 32 bit)

Mac OS X V10.4 & above

Linux (2.6x) & above

Not support Windows 2000 and earlier versions.

	Windows7*4	Windows7*5	Vista	XP	Mac OSX	Linux
Default mouse*1	○	○	○	○	○	○
Touch digitizer*2	○	○	○	×	×	×
Windows7 gestures*3	○	×	×	×	×	×

*1 Default mouse (click, drag, double-click and right-click)

*2 Touch digitizer (click, drag /selection, double-click, right-click, flick and visual feedback)

*3 Digitizer with Windows7 multi-touch gestures

*4 Windows 7 - Starter and Home Basic version

*5 Windows 7 - Home Premium, Professional, Enterprise and Ultimate versions

OPERATING THE MONITOR

To create the best picture, your iiyama LCD monitor has been preset at the factory with the COMPLIANT TIMING shown on page 41. You are also able to adjust the picture by following the button operation shown below. For more detailed adjustments, see page 30 for SCREEN ADJUSTMENTS.

- 1 Press the MENU Button to start the On Screen Display feature. There are additional Menu items which can be switched by using the ▲ / ▼ Buttons.

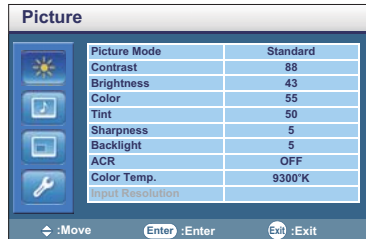

- 2 Select the Menu item of the adjustment you want to make. Press the ► or ENTER Buttons and enter the menu page. Then, use the ▲ / ▼ Buttons to highlight the desired adjustment item.
- 3 Press the ► or ENTER Buttons again. Use the ◀ / ▶ Buttons to make the appropriate adjustment or setting.
- 4 Press the EXIT Button to leave the menu, and the settings you just made would be automatically saved.

For example, to correct for vertical position, select Menu item of Option. Then, select "V. Position" by using the ► Buttons.

Use the ▲ / ▼ Buttons to change the vertical position settings. The vertical position of the overall display should be changing accordingly while you are doing this.

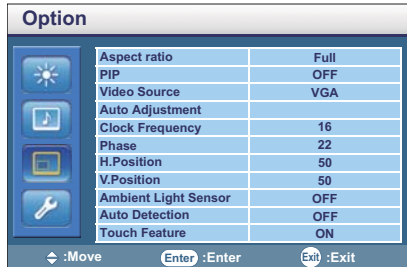

Press the EXIT Button lastly, it ends, all changes are saved in the memory.

NOTE

- The MENU / EXIT Button can be used to return previous menu item.
- Any changes are automatically saved in the memory when the On Screen Display disappears. Turning off the power should be avoided while using the Menu.
- Adjustments for Image Position, Clock Frequency and Phase are saved for each signal timing. Except for these adjustments, all other adjustments have only one setting which applies to all signal timings.

[LOCK MODE] * Available for Back Controller only.

● **Control Panel Button:**

Pressing and holding the ◀ / ▶ buttons for about 5 seconds when Menu is not displayed, will lock/unlock the Control Panel Button Lock function.

● **Remote Control Function:**

Pressing and holding the Menu and ▶ buttons for about 5 seconds when Menu is not displayed, will lock/unlock the Remote Control Lock function.

● **OSD Menu Function:**

Pressing and holding the ▲ / ▼ buttons for about 5 seconds when Menu is not displayed, will lock/unlock the OSD Menu Lock function.

● **Power On/Off Function:**

Pressing and holding the Menu and ◀ buttons for about 5 seconds when Menu is not displayed, will lock/unlock the Power On/Off Lock function.

[OPENING iiyama LOGO] * Available for Remote Control only.

Pressing and holding the Enter button for about 3 seconds when Menu is not displayed, will lock/unlock the Opening Logo function.

ADJUSTMENT MENU CONTENTS





Picture		Picture	
Adjustment Item	Problem / Option		Button to Press
Picture Mode* ²	Standard	For general windows environment and monitor default setting.	
	Vivid	For displaying outdoor scenery images.	
	Cinema	For movie and video environment.	
	User	Displays a picture on a screen set by Image Settings adjustments.	
Contrast	Too dull	← →	
	Too intense	← →	
Brightness* ¹	Too dark	← →	
	Too bright	← →	
Color* ²	Too weak	← →	
	Too strong	← →	
Tint* ²	Purplish	← →	
	Greenish	← →	
Sharpness	Too soft	← →	
	Too sharp	← →	
Backlight* ³	Brightness of back light is reduced.		← →
ACR* ³	ON	Increased Contrast Ratio	
	OFF	Typical Contrast Ratio	
Color Temp.	12000°K	Strong Bluish white	
	9300°K	Bluish white	
	6500°K	Reddish white	
	User	Red	Too weak Too strong
	Green		
	Blue		
Input Resolution	Not available on this model.		

*¹ Adjust the Brightness when you are using the monitor in a dark room and feel the screen is too bright.

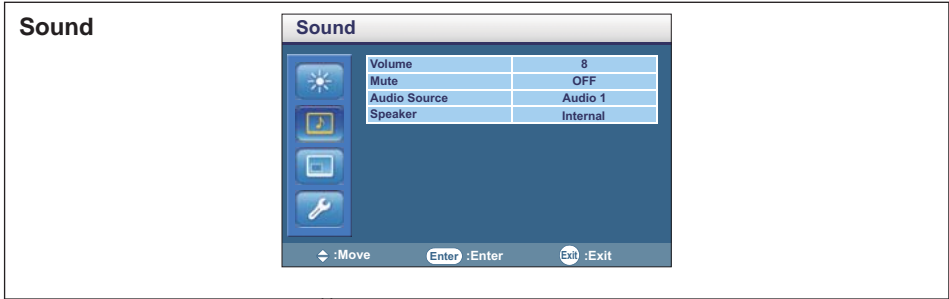
*² Only AV,S-Video and YPbPr inputs.

*³ Backlight and ACR are disabled when the Ambient Light Sensor is active.



Adjustment Item	Problem / Option		Button to Press
Volume	Too soft Too loud		   
Mute	ON	Turn off the sound temporarily.	
	OFF	Return the sound volume to the previous level.	
Audio Source	Audio1	Select the Audio1 input.	
	Audio2	Select the Audio2 input.	
	Audio3	Select the Audio3 input.	
	HDMI*	Select the HDMI input.	
Speaker	Internal	Select the Internal Speaker.	
	External	Select the External Speaker.	
	Line-out	Select the Line-out.	

* Suitable for HDMI input only.

Option

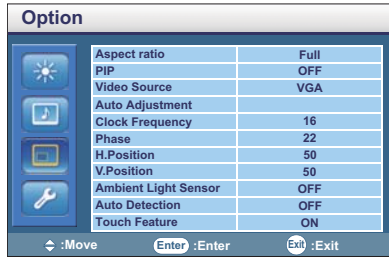

Adjustment Item	Problem / Option		Button to Press
Aspect Ratio*5	Full	Expansion display	
	Original	Displayed at the same magnification.	
PIP*1,5	ON/OFF	Change the ON / OFF of the PIP function.	
	Main Input	Select from the input signals VGA and YPbPr of the Main screen.	
	Sub Input	Select from the input signals DVI and HDMI of the Sub screen.	
	PIP Size	Select from a size "Large", "Middle" and "Small" of the Sub screen.	
	PIP Position	Move the position of the Sub screen.	
Video Source	AV	Select the AV input.	
	S-Video	Select the S-Video input.	
	VGA	Select the VGA input.	
	YPbPr	Select the YPbPr input.	
	DVI	Select the DVI input.	
	HDMI	Select the HDMI input.	

NOTE When only one of the seven signal inputs is connected to the signal source, the one connected is automatically selected. Select Source function is not available if there is no signal input from the selected connector or during the power management mode.

Auto Adjustment*2,3	Adjust Position, Clock Frequency and Phase automatically.		
Clock Frequency*2,5	Too narrow		
	Too wide		
Phase*2,5	To correct flickering text or lines		
H Position*2,5	Too far to the left		
	Too far to the right		
V Position*2,5	Too low		
	Too high		

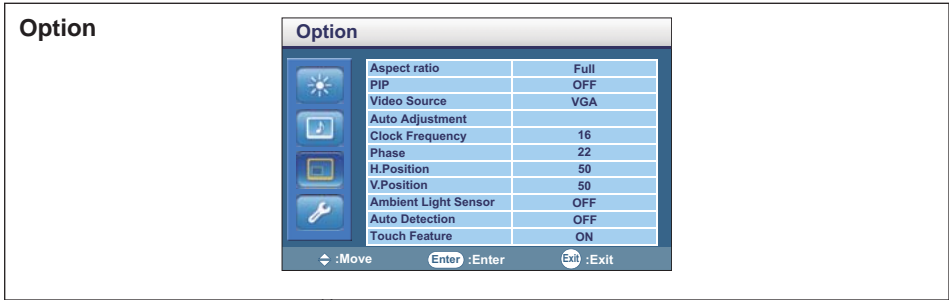

Adjustment Item	Problem / Option		Button to Press
Ambient Light Sensor	HIGH	To increase the brightness of ambient light compensation.	
	LOW	To decrease the brightness of ambient light compensation.	
	OFF	Light sensor is turned off.	
Auto Detection	ON	Automatically detects available input sources.	
	OFF	Return to Menu.	
Touch Feature* ⁴	ON	To streamline the OSD, then grayout the following functions: Aspect Ratio, PIP Mode, Clock Frequency, Phase, H Position, V Position and Display - Wall	
	OFF	Return to Menu.	

*¹ PIP = Picture in Picture

With this function, you can display two different picture.

PIP support details, See page 42 "PIP Support Screen Table" and "Support Signal Source and Resolution in PIP Mode".

*² Only Analog input.

*³ For best results, use the Auto Adjust in conjunction with the adjustment pattern. See page 30 for SCREEN ADJUSTMENTS.

*⁴ Only VGA, DVI and HDMI inputs. And, available for ProLite TH5563MTS / ProLite TH5563MIS only.

*⁵ If the Touch Feature is enabled, this feature is not available.

Setting

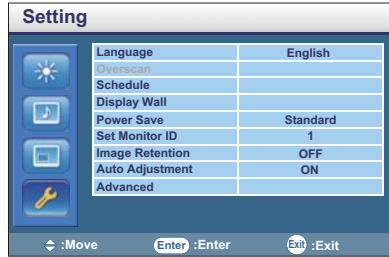

Adjustment Item	Problem / Option		Button to Press	
Language	English	English	Русский	Russian
	Français	French	PolSKI	Polish
	Español	Spanish	Nederlands	Dutch
	Deutsch	German		
Overscan	Not available on this model.			
Schedule	Date and Time	Sets the date and time. Year/Month/Day/Hour/Minute/Daylight Saving Time Displays the current date and time. Current Date/Current Time		
	Schedule	Sets the auto power feature.(7 pattern) On(Time)/Off(Time)/Input Source		
Display Wall*	H Monitor	Sets the number of displays used in the horizontal position.		
	V Monitor	Sets the number of displays used in the vertical position.		
	H Position	Sets the horizontal position of the display wall matrix.		
	V Position	Sets the vertical position of the display wall matrix.		
	Frame comp.	ON	Adjusts images near the display edges for optimal demonstration across the display wall.	
Power Save	OFF	Return to Menu.		
	Eco	All sources can enter the power saving mode, but only a VGA signal can wake up the display or you have to press the power button to wake up the display when other source is connected.		
	Standard	All sources can enter the power saving mode and wake up the display.		
	VGA Only	Only the VGA signal can enter the power saving mode and wake up the display.		
Set Monitor ID	Set ID to the Monitor. 1-255			
Image Retention	ON	Automatically displays swift moving patterns every 10 seconds to prevent image retention on the screen.		
	OFF	Return to Menu.		

Setting			
Adjustment Item	Problem / Option		Button to Press
Auto Adjustment	ON	When a new signal is input, adjust Position, Clock Frequency and Phase automatically.	
	OFF	Return to Menu.	
Advanced	Press ► button.		

**Setting
Advanced**

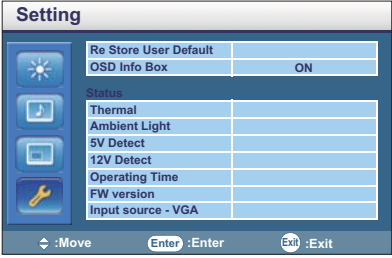

Adjustment Item	Problem / Option		Button to Press
Restore User Default	Confirm	Factory-preset data is restored.	
	Return	Return to Menu.	
OSD Info Box	ON	Displays the status of the monitor.	
	OFF	Return to Menu.	

NOTE **Status Item**

Thermal: Shows current temperature inside the display.
 Ambient Light: Shows current ambient brightness around the display.
 5V Detect: Shows the current 5V voltage detection result.
 12V Detect: Shows the current 12V voltage detection result.
 Operating Time: Shows the time elapsed since the display was last turned on.
 FW version: Shows the Firmware version.
 Input source - VGA: Shows the Input source of VGA.

* The best performance would be 2x2.
 If the Display - wall is more than 3x3, we suggest use video splitter.
 And, VGA, RS232C and AV input can do daisy chain.
 If the Touch Feature is enabled, this feature is not available.

SCREEN ADJUSTMENTS

Adjust the image by following the procedure below to get the desired picture when selecting Analog input.

- The screen adjustments described in this manual are designed to set image position and minimize flicker or blur for the particular computer in use.
- The monitor is designed to provide the best performance at resolution of 1920 × 1080, but can not provide the best at resolutions of less than 1920 × 1080 because the picture is automatically stretched to fit the full screen. It is recommended to operate at resolution of 1920 × 1080 in normal use.
- Displayed text or lines will be blurred or irregular in thickness when the picture is stretched due to the screen enlargement process.
- It is preferable to adjust the image position and frequency with the monitor controls, rather than the computer software or utilities.
- Perform adjustments after a warm-up period of at least thirty minutes.
- Additional adjustments may be required after the Auto Adjust depending on the resolution or signal timing.
- The Auto Adjust may not work correctly when displaying the picture other than the screen adjustment pattern. In this case, manual adjustments are required.

There are two ways to adjust the screen. One way is automatic adjustment for Position, Clock Frequency and Phase. The other way is performing each adjustment manually.

Perform the Auto Adjust first when the monitor is connected to a new computer, or resolution is changed. If the screen has a flicker or blur, or the picture does not fit in the display area after performing the Auto Adjust, manual adjustments are required. Both adjustments should be made by using the screen adjustment pattern (Test.bmp) obtained via the IYAMA web site (<http://www.iiyama.com>).

Adjust the image by following the procedure below to get the desired picture.

This manual explains adjustment under Windows® OS.

- ① **Display the picture at the optimum resolution.**
- ② **Enter the Test.bmp (screen adjustment pattern) to wallpaper.**

NOTE

- Consult the appropriate documentation for doing this.
- Test.bmp is made at resolution of 1280 × 1024. Set the display position to center in the wallpaper setting dialogue box.

[Adjustment pattern]

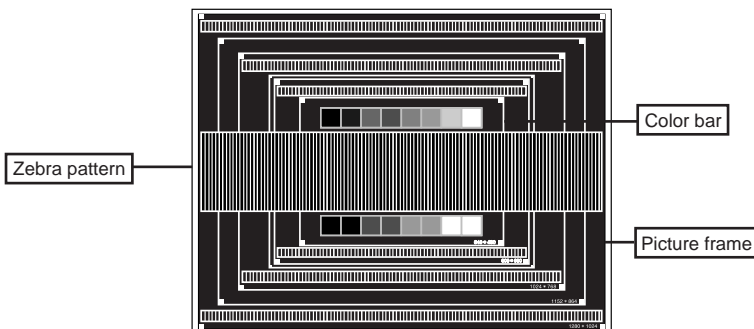

- ③ Adjust the Auto Adjustment.
- ④ Adjust the image manually by following procedure below when the screen has a flicker or blur, or the picture does not fit in the display area after performing the Auto Adjust.
- ⑤ Adjust the V-Position so that the top and bottom of the picture frame will fit to the display area.

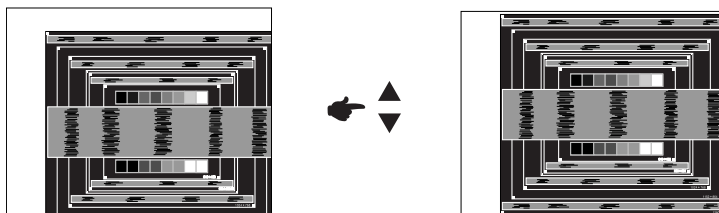

- ⑥ 1) Adjust the H-Position so that the left side of the picture frame will move to the left edge of the display area.

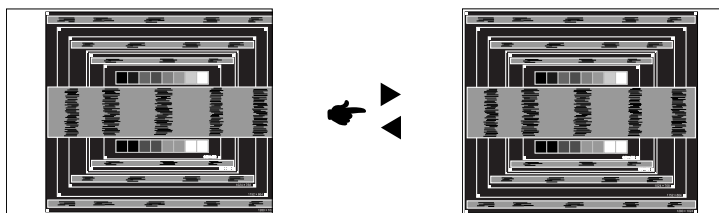

- 2) Stretch the right side of the picture frame to the right edge of the display area by adjusting the Clock Frequency.

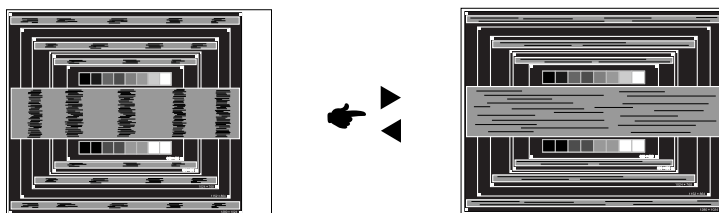
**NOTE**

- When the left side of the picture frame moves apart from the left edge of the display area during the Clock Frequency adjustment, adjust steps 1) and 2).
- Another way to make the Clock Frequency adjustment is to correct the vertical wavy lines in the zebra pattern.
- The picture may flicker during the Clock Frequency, H/V-Position adjustment.
- In case the picture frame is bigger or smaller than the data display area after the Clock Frequency adjustment, repeat steps from ③.

- ⑦ Adjust the Phase to correct horizontal wavy noise, flicker or blur in the zebra pattern.

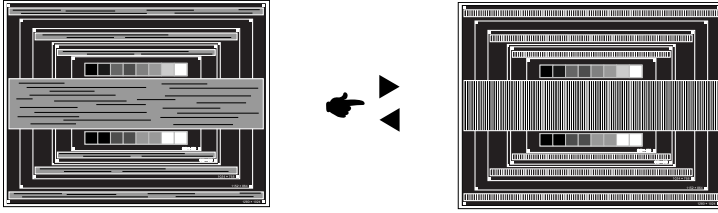
**NOTE**

- In case the strong flicker or blurs remain on a part of the screen, repeat steps ⑥ and ⑦ because the Clock Frequency may not be adjusted correctly. If the flicker or blurs still remain, set the refresh rate of computer to low (60Hz) and repeat steps from ③ again.
- Adjust the H-Position after the Phase adjustment if the horizontal position moves during the adjustment.

- ⑧ Adjust the Brightness and Color to get the desired picture after you complete the Clock Frequency and Phase adjustments.

Put back your favorite wallpaper.

POWER MANAGEMENT FEATURE

The power management feature of this product complies with power saving requirement of VESA DPMS. When activated, it automatically reduces unnecessary power consumption of the monitor when your computer is not in use.

To use the feature, the monitor needs to be connected to a VESA DPMS compliant computer. There is a power management step the monitor takes as described below. The power management function, including any timer settings is configured by the operating system. Check your operating system manual for information on how this can be configured.

■ Power Management Mode (By "ECO" or "VGA only" turn ON of Power Save function.)

When the H-sync signal / V-sync signal / H and V sync signals from the computer are off, the monitor enters into Power Management Mode which reduces the power consumption to less than 0.5W. The screen becomes dark. From Power Management Mode, the image reappears in several seconds when either the keyboard or the mouse are touched again.

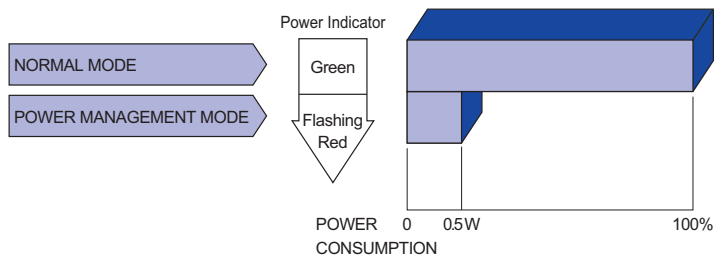

NOTE

- Even when using the power management mode, the monitor consumes electricity. Turn off the Power Switch whenever the monitor is not in use, during the night and weekends, to avoid unnecessary power consumption.
- It is possible that the video signal from the computer may be on while the H or V sync signal is missing. In this instance, the POWER MANAGEMENT feature may not work properly.

TROUBLE SHOOTING

If the monitor fails to operate correctly, please follow the steps below for a possible solution.

1. Perform the adjustments described in OPERATING THE MONITOR, depending on the problem you have. If the monitor does not get a picture, skip to 2.
2. Consult the following items if you cannot find an appropriate adjustment item in OPERATING THE MONITOR or if the problem persists.
3. If you are experiencing a problem which is not described below or you cannot correct the problem, discontinue using the monitor and contact your dealer or iiyama service center for further assistance.

Problem	Check
① The picture does not appear.	<input type="checkbox"/> The Power Cable is firmly seated in the socket. <input type="checkbox"/> The Power Switch is turned ON. <input type="checkbox"/> The AC socket is live. Please check with another piece of equipment. <input type="checkbox"/> If the blank screen saver is in active mode, touch the keyboard or the mouse. <input type="checkbox"/> Increase the Contrast and/or Brightness. <input type="checkbox"/> The computer is ON. <input type="checkbox"/> The Signal Cable is properly connected. <input type="checkbox"/> The signal timing of the computer is within the specification of the monitor. <input type="checkbox"/> If the monitor is in power management mode, touch the keyboard or the mouse.
② The screen is not synchronized.	<input type="checkbox"/> The Signal Cable is properly connected. <input type="checkbox"/> The signal timing of the computer is within the specification of the monitor. <input type="checkbox"/> The video output level of the computer is within the specification of the monitor.
③ The screen position is not in the center.	<input type="checkbox"/> The signal timing of the computer is within the specification of the monitor.
④ The screen is too bright or too dark.	<input type="checkbox"/> The video output level of the computer is within the specification of the monitor.
⑤ The screen is shaking.	<input type="checkbox"/> The power voltage is within the specification of the monitor. <input type="checkbox"/> The signal timing of the computer is within the specification of the monitor.
⑥ No sound.	<input type="checkbox"/> The audio equipment (computer etc.) is ON. <input type="checkbox"/> The Audio Cable is properly connected. <input type="checkbox"/> The Volume is turned up. <input type="checkbox"/> The Mute is OFF. <input type="checkbox"/> The audio output level of the audio equipment is within the specification of the monitor.
⑦ The sound is too loud or too quiet.	<input type="checkbox"/> The audio output level of the audio equipment is within the specification of the monitor.
⑧ A strange noise is heard.	<input type="checkbox"/> The Audio Cable is properly connected.
⑨ The touch screen shows no response.	<input type="checkbox"/> The USB Cable is firmly seated in the socket. <input type="checkbox"/> Touch screen driver software is installed.
⑩ The touch position does not deviate.	<input type="checkbox"/> The calibration function set up correctly.

RECYCLING INFORMATION

For better environment protection please don't dispose your monitor.
Please visit our web site: www.iiyama.com/recycle for monitor recycling.

APPENDIX

Design and specifications are subject to change without prior notice.

SPECIFICATIONS : ProLite TH5563MTS

ENGLISH

Touch Screen	Technology	Optical (2point by Windows7)	
	Light transmission	88%	
	Communication system	USB serial transfer	
Size Category		55"	
LCD Panel	Panel technology	IPS	
	Size	Diagonal: 55" (138cm)	
	Pixel pitch	0.63mm H x 0.63mm V	
	Brightness	450cd/m ² (Typical)	
	Contrast ratio	1300 : 1 (Typical)	
	Viewable angle	Horizontal : 178 degrees, Vertical: 178 degrees (Typical)	
	Response time	12ms (Typical: Gray to Gray)	
Display Colors		Approx.1.073G	
Sync Frequency		Horizontal: 30.0-75.0kHz, Vertical: 50-75Hz	
Maximum Resolution		1920 x 1080, 2.1 MegaPixels	
Input Connector		D-Sub mini 15 pin, DVI-D 24 pin, HDMI	
Input Video Connector		RCA, S-Video	
Serial Port		RS-232C In/Out	
Plug & Play		VESA DDC2B™	
Input Sync Signal		Separate sync: TTL, Positive or Negative	
Input Video Signal		Analog: 0.7Vp-p (Standard), 75Ω, Positive Digital: DVI (Digital Visual Interface Standard Rev.1.0) compliance Digital: HDMI	
Input Audio Connector		mini jack, RCA (L/R) x2	
Input Component Connector		RCA (Video/L/R)	
Input Audio Signal		0.5Vrms maximum	
Output Connector		D-Sub mini 15 pin	
Output Video Connector		RCA	
Output Audio Connector		RCA(L/R)	
Speakers		Internal: 10Wx2 (Stereo speakers), External speaker jack: 12Wx2	
Maximum Screen Size		1209.6mm W x 680.4mm H / 47.6" W x 26.8" H	
Power Source		100-240VAC, 50/60Hz, 6A	
Power Consumption*		142W typical, Power management mode: 0.5W maximum	
Dimensions / Net Weight		1263.0 x 744.0 x 95.0mm / 49.7 x 29.3 x 3.7" (WxHxD) 45.0kg / 99.2lbs	
Environmental Considerations		Operating: Temperature 0 to 40°C / 32 to 104°F Humidity 10-90% (No condensation) Storage: Temperature -20 to 60°C / 4 to 140°F Humidity 10-95% (No condensation)	
Approvals		CB, CE, TÜV-Bauart	

NOTE * USB peripherals / Audio equipment are not connected.

SPECIFICATIONS : ProLite TH5563MIS

Touch Screen	Technology	IR (6point by Windows7)
	Light transmission	88%
	Communication system	USB serial transfer
Size Category		55"
LCD Panel	Panel technology	IPS
	Size	Diagonal: 55" (138cm)
	Pixel pitch	0.63mm H x 0.63mm V
	Brightness	450cd/m ² (Typical)
	Contrast ratio	1300 : 1 (Typical)
	Viewable angle	Horizontal : 178 degrees, Vertical: 178 degrees (Typical)
	Response time	12ms (Typical: Gray to Gray)
Display Colors		Approx.1.073G
Sync Frequency		Horizontal: 30.0-75.0kHz, Vertical: 50-75Hz
Maximum Resolution		1920 x 1080, 2.1 MegaPixels
Input Connector		D-Sub mini 15 pin, DVI-D 24 pin, HDMI
Input Video Connector		RCA, S-Video
Serial Port		RS-232C In/Out
Plug & Play		VESA DDC2B™
Input Sync Signal		Separate sync: TTL, Positive or Negative
Input Video Signal		Analog: 0.7Vp-p (Standard), 75Ω, Positive Digital: DVI (Digital Visual Interface Standard Rev.1.0) compliance Digital: HDMI
Input Audio Connector		mini jack, RCA (L/R) x2
Input Component Connector		RCA (Video/L/R)
Input Audio Signal		0.5Vrms maximum
Output Connector		D-Sub mini 15 pin
Output Video Connector		RCA
Output Audio Connector		RCA(L/R)
Speakers		Internal: 10Wx2 (Stereo speakers), External speaker jack: 12Wx2
Maximum Screen Size		1209.6mm W x 680.4mm H / 47.6" W x 26.8" H
Power Source		100-240VAC, 50/60Hz, 6A
Power Consumption*		136W typical, Power management mode: 0.5W maximum
Dimensions / Net Weight		1273.0 x 743.5 x 96.0mm / 50.1 x 29.3 x 3.8" (WxHxD) 45.0kg / 99.2lbs
Environmental Considerations		Operating: Temperature 0 to 40°C / 32 to 104°F Humidity 10-90% (No condensation) Storage: Temperature -20 to 60°C / 4 to 140°F Humidity 10-95% (No condensation)
Approvals		CB, CE, TÜV-Bauart

NOTE * USB peripherals / Audio equipment are not connected.

SPECIFICATIONS : ProLite LH5563S

Size Category	55"	
LCD Panel	Panel technology	IPS
	Size	Diagonal: 55" (138cm)
	Pixel pitch	0.63mm H × 0.63mm V
	Brightness	450cd/m ² (Typical)
	Contrast ratio	1300 : 1 (Typical)
	Viewable angle	Horizontal : 178 degrees, Vertical: 178 degrees (Typical)
	Response time	12ms (Typical: Gray to Gray)
Display Colors	Approx.1.073G	
Sync Frequency	Horizontal: 30.0-75.0kHz, Vertical: 50-75Hz	
Maximum Resolution	1920 × 1080, 2.1 MegaPixels	
Input Connector	D-Sub mini 15 pin, DVI-D 24 pin, HDMI	
Input Video Connector	RCA, S-Video	
Serial Port	RS-232C In/Out	
Plug & Play	VESA DDC2B™	
Input Sync Signal	Separate sync: TTL, Positive or Negative	
Input Video Signal	Analog: 0.7Vp-p (Standard), 75Ω, Positive Digital: DVI (Digital Visual Interface Standard Rev.1.0) compliance Digital: HDMI	
Input Audio Connector	mini jack, RCA (L/R) x2	
Input Component Connector	RCA (Video/L/R)	
Input Audio Signal	0.5Vrms maximum	
Output Connector	D-Sub mini 15 pin	
Output Video Connector	RCA	
Output Audio Connector	RCA(L/R)	
Speakers	Internal: 10Wx2 (Stereo speakers), External speaker jack: 12Wx2	
Maximum Screen Size	1209.6mm W × 680.4mm H / 47.6" W × 26.8" H	
Power Source	100-240VAC, 50/60Hz, 5.5A	
Power Consumption*	136W typical, Power management mode: 0.5W maximum	
Dimensions / Net Weight	1260.0 × 732.0 × 59.0mm / 49.6 × 28.8 × 2.3" (WxHxD) 27.2kg / 60.0lbs	
Environmental Considerations	Operating: Temperature	0 to 40°C / 32 to 104°F
	Humidity	10-90% (No condensation)
	Storage: Temperature	-20 to 60°C / 4 to 140°F
	Humidity	10-95% (No condensation)
Approvals	CB, CE, TÜV-Bauart	

NOTE * Audio equipment are not connected.

DIMENSIONS

■ ProLite TH5563MTS

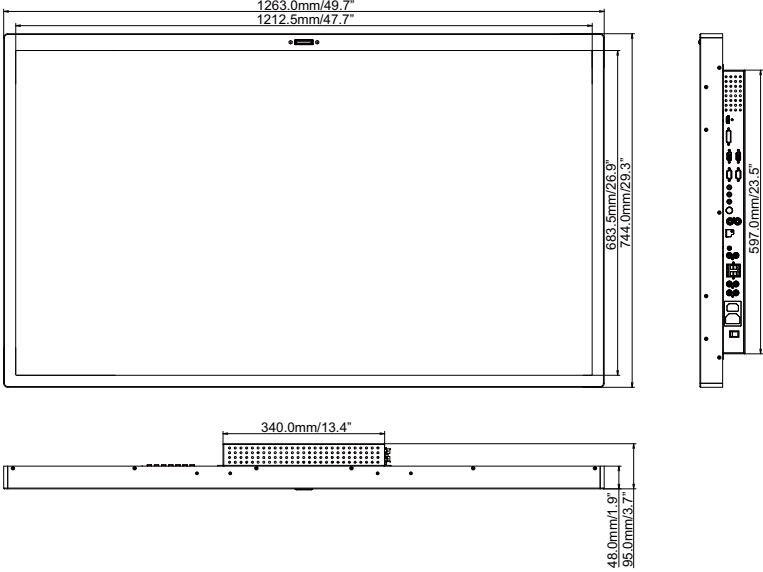

■ ProLite TH5563MIS

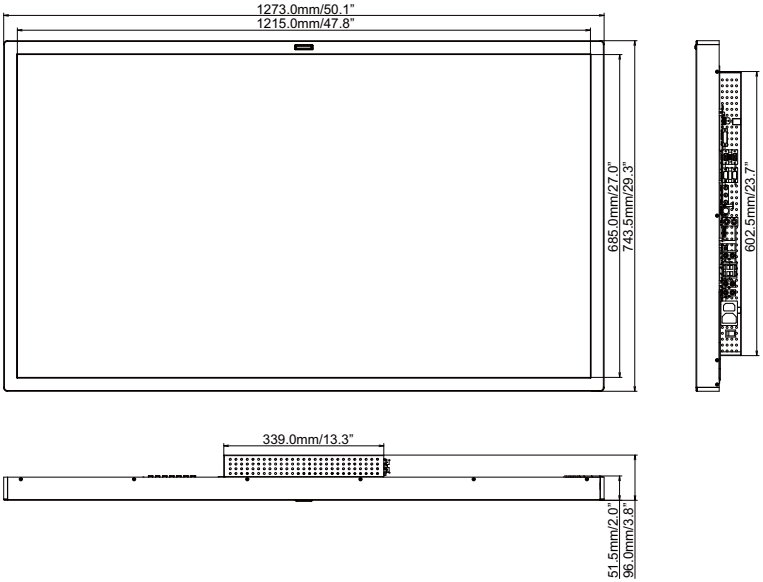

■ProLite LH5563S

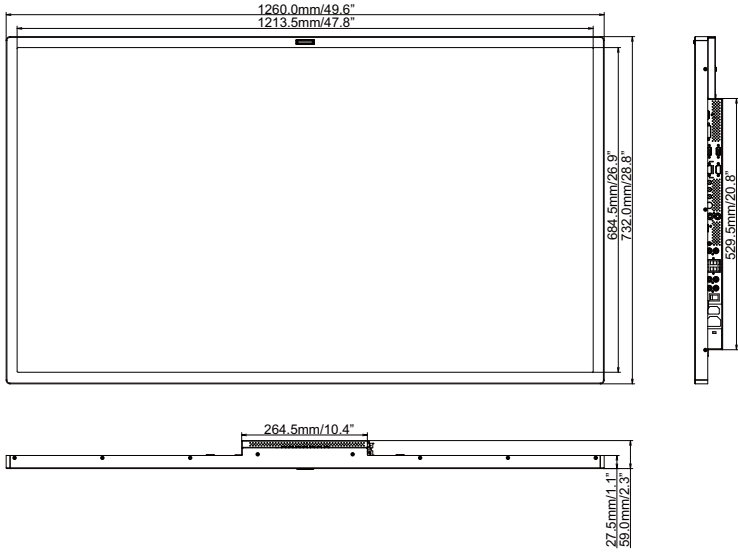

COMPLIANT TIMING

Timing		fH(kHz)	fV(Hz)	Dot clock (MHz)	HDMI	VGA	Component(AA)	S-Video(AA)	Composite(AA)	DVI(AA)
VESA	VGA 640x480	31.469	59.940	25.175	○	○				○
		37.861	72.809	31.500	○	○				○
		37.500	75.000	31.500	○	○				○
	SVGA 800x600	35.156	56.250	36.000	○	○				○
		37.879	60.317	40.000	○	○				○
		48.077	72.188	50.000	○	○				○
		46.875	75.000	49.500	○	○				○
	XGA 1024x768	48.363	60.004	65.000	○	○				○
		56.476	70.069	75.000	○	○				○
		60.023	75.029	78.750	○	○				○
	WXGA 1360x768	47.712	60.015	85.500	○	○				○
	1280x768	47.396	59.995	68.250	○	○				○
	SXGA 1280x1024	63.981	60.020	108.000	○	○				○
UXGA 1600x1200	75.000	60.000	162.000	○	○				○	
1920x1080	66.587	59.930	138.500	○	○				○	
SDTV	NTSC	15.734	29.970	13.500	480i		480i	○	○	
	PAL	15.625	25.000	13.500	576i		576i	○	○	
EDTV	480p	31.500	60.000	27.030	○		○			
	576p	31.250	50.000	27.000	○		○			
HDTV	720p 1280x720	37.500	50.000	74.250	○		○			
		44.995	59.940	74.176	○		○			
		45.000	60.000	74.250	○		○			
	1080i 1920x1080	28.130	50.000	74.250	○		○			
		33.716	59.940	74.176	○		○			
		33.750	60.000	74.250	○		○			
	1080p 1920x1080	56.250	50.000	148.500	○		○			
		67.433	59.940	148.352	○		○			
		67.500	60.000	148.500	○		○			

*1 ○ means supported the timing.

*2 480i means supported 480i@60Hz(YPbPr).

*3 576i means supported 576i@60Hz(YPbPr).

PIP SUPPORT SCREEN TABLE

PIP Support Screen Table

Sub \ Main	AV	S-Video	VGA	YPbPr	DVI	HDMI
AV	—	—	—	—	—	—
S-Video	—	—	—	—	—	—
VGA	—	—	—	—	○	○
YPbPr	—	—	—	—	○	○
DVI	—	—	○	○	—	—
HDMI	—	—	○	○	—	—

ENGLISH

Support Signal Source and Resolution in PIP Mode

* ○ means supported the timing.

Main \ Sub		VGA													
		640x480 @60Hz	640x480 @72Hz	640x480 @75Hz	720x400 @70Hz	800x600 @60Hz	800x600 @75Hz	1024x768 @60Hz	1024x768 @75Hz	1280x768 @60Hz	1280x960 @60Hz	1280x1024 @60Hz	1360x768 @60Hz	1600x1200 @60Hz	1920x1080 @60Hz
DVI	640x480 @60Hz	○	○	○	○	○	○	○	○	○	○	○	○	○	○
	640x480 @72Hz	○	○	○	○	○	○	○	○	○	○	○	○	○	○
	640x480 @75Hz	○	○	○	○	○	○	○	○	○	○	○	○	○	○
	720x400 @70Hz	○	○	○	○	○	○	○	○	○	○	○	○	○	○
	800x600 @60Hz	○	○	○	○	○	○	○	○	○	○	○	○	○	○
	800x600 @75Hz	○	○	○	○	○	○	○	○	○	○	○	○	○	○
	1024x768 @60Hz	○	○	○	○	○	○	○	○	○	○	○	○	○	○
	1024x768 @75Hz	○	○	○	○	○	○	○	○	○	○	○	○	○	○
	1280x768 @60Hz	○	○	○	○	○	○	○	○	○	○	○	○	○	○
	1280x960 @60Hz	○	○	○	○	○	○	○	○	○	○	○	○	○	○
	1280x1024 @60Hz	○	○	○	○	○	○	○	○	○	○	○	○	○	○
	1360x768 @60Hz	○	○	○	○	○	○	○	○	○	○	○	○	○	○
	1600x1200 @60Hz	○	○	○	○	○	○	○	○	○	○	○	○	○	○
1920x1080 @60Hz	○	○	○	○	○	○	○	○	○	○	○	○	○	○	

		Main	VGA																		
			640x480 @60Hz	640x480 @72Hz	640x480 @75Hz	720x400 @70Hz	800x600 @60Hz	800x600 @75Hz	1024x768 @60Hz	1024x768 @75Hz	1280x768 @60Hz	1280x960 @60Hz	1280x1024 @60Hz	1360x768 @60Hz	1600x1200 @60Hz	1920x1080 @60Hz					
Sub	640x480 @60Hz	<input type="checkbox"/>	<input type="checkbox"/>	<input type="checkbox"/>	<input type="checkbox"/>	<input type="checkbox"/>	<input type="checkbox"/>	<input type="checkbox"/>	<input type="checkbox"/>	<input type="checkbox"/>	<input type="checkbox"/>	<input type="checkbox"/>	<input type="checkbox"/>	<input type="checkbox"/>	<input type="checkbox"/>	<input type="checkbox"/>	<input type="checkbox"/>	<input type="checkbox"/>	<input type="checkbox"/>	<input type="checkbox"/>	<input type="checkbox"/>
	640x480 @72Hz	<input type="checkbox"/>	<input type="checkbox"/>	<input type="checkbox"/>	<input type="checkbox"/>	<input type="checkbox"/>	<input type="checkbox"/>	<input type="checkbox"/>	<input type="checkbox"/>	<input type="checkbox"/>	<input type="checkbox"/>	<input type="checkbox"/>	<input type="checkbox"/>	<input type="checkbox"/>	<input type="checkbox"/>	<input type="checkbox"/>	<input type="checkbox"/>	<input type="checkbox"/>	<input type="checkbox"/>	<input type="checkbox"/>	<input type="checkbox"/>
	640x480 @75Hz	<input type="checkbox"/>	<input type="checkbox"/>	<input type="checkbox"/>	<input type="checkbox"/>	<input type="checkbox"/>	<input type="checkbox"/>	<input type="checkbox"/>	<input type="checkbox"/>	<input type="checkbox"/>	<input type="checkbox"/>	<input type="checkbox"/>	<input type="checkbox"/>	<input type="checkbox"/>	<input type="checkbox"/>	<input type="checkbox"/>	<input type="checkbox"/>	<input type="checkbox"/>	<input type="checkbox"/>	<input type="checkbox"/>	<input type="checkbox"/>
	720x400 @70Hz	<input type="checkbox"/>	<input type="checkbox"/>	<input type="checkbox"/>	<input type="checkbox"/>	<input type="checkbox"/>	<input type="checkbox"/>	<input type="checkbox"/>	<input type="checkbox"/>	<input type="checkbox"/>	<input type="checkbox"/>	<input type="checkbox"/>	<input type="checkbox"/>	<input type="checkbox"/>	<input type="checkbox"/>	<input type="checkbox"/>	<input type="checkbox"/>	<input type="checkbox"/>	<input type="checkbox"/>	<input type="checkbox"/>	<input type="checkbox"/>
	800x600 @60Hz	<input type="checkbox"/>	<input type="checkbox"/>	<input type="checkbox"/>	<input type="checkbox"/>	<input type="checkbox"/>	<input type="checkbox"/>	<input type="checkbox"/>	<input type="checkbox"/>	<input type="checkbox"/>	<input type="checkbox"/>	<input type="checkbox"/>	<input type="checkbox"/>	<input type="checkbox"/>	<input type="checkbox"/>	<input type="checkbox"/>	<input type="checkbox"/>	<input type="checkbox"/>	<input type="checkbox"/>	<input type="checkbox"/>	<input type="checkbox"/>
	800x600 @75Hz	<input type="checkbox"/>	<input type="checkbox"/>	<input type="checkbox"/>	<input type="checkbox"/>	<input type="checkbox"/>	<input type="checkbox"/>	<input type="checkbox"/>	<input type="checkbox"/>	<input type="checkbox"/>	<input type="checkbox"/>	<input type="checkbox"/>	<input type="checkbox"/>	<input type="checkbox"/>	<input type="checkbox"/>	<input type="checkbox"/>	<input type="checkbox"/>	<input type="checkbox"/>	<input type="checkbox"/>	<input type="checkbox"/>	<input type="checkbox"/>
	1024x768 @60Hz	<input type="checkbox"/>	<input type="checkbox"/>	<input type="checkbox"/>	<input type="checkbox"/>	<input type="checkbox"/>	<input type="checkbox"/>	<input type="checkbox"/>	<input type="checkbox"/>	<input type="checkbox"/>	<input type="checkbox"/>	<input type="checkbox"/>	<input type="checkbox"/>	<input type="checkbox"/>	<input type="checkbox"/>	<input type="checkbox"/>	<input type="checkbox"/>	<input type="checkbox"/>	<input type="checkbox"/>	<input type="checkbox"/>	<input type="checkbox"/>
	1024x768 @75Hz	<input type="checkbox"/>	<input type="checkbox"/>	<input type="checkbox"/>	<input type="checkbox"/>	<input type="checkbox"/>	<input type="checkbox"/>	<input type="checkbox"/>	<input type="checkbox"/>	<input type="checkbox"/>	<input type="checkbox"/>	<input type="checkbox"/>	<input type="checkbox"/>	<input type="checkbox"/>	<input type="checkbox"/>	<input type="checkbox"/>	<input type="checkbox"/>	<input type="checkbox"/>	<input type="checkbox"/>	<input type="checkbox"/>	<input type="checkbox"/>
	1280x768 @60Hz	<input type="checkbox"/>	<input type="checkbox"/>	<input type="checkbox"/>	<input type="checkbox"/>	<input type="checkbox"/>	<input type="checkbox"/>	<input type="checkbox"/>	<input type="checkbox"/>	<input type="checkbox"/>	<input type="checkbox"/>	<input type="checkbox"/>	<input type="checkbox"/>	<input type="checkbox"/>	<input type="checkbox"/>	<input type="checkbox"/>	<input type="checkbox"/>	<input type="checkbox"/>	<input type="checkbox"/>	<input type="checkbox"/>	<input type="checkbox"/>
	1280x960 @60Hz	<input type="checkbox"/>	<input type="checkbox"/>	<input type="checkbox"/>	<input type="checkbox"/>	<input type="checkbox"/>	<input type="checkbox"/>	<input type="checkbox"/>	<input type="checkbox"/>	<input type="checkbox"/>	<input type="checkbox"/>	<input type="checkbox"/>	<input type="checkbox"/>	<input type="checkbox"/>	<input type="checkbox"/>	<input type="checkbox"/>	<input type="checkbox"/>	<input type="checkbox"/>	<input type="checkbox"/>	<input type="checkbox"/>	<input type="checkbox"/>
	1280x1024 @60Hz	<input type="checkbox"/>	<input type="checkbox"/>	<input type="checkbox"/>	<input type="checkbox"/>	<input type="checkbox"/>	<input type="checkbox"/>	<input type="checkbox"/>	<input type="checkbox"/>	<input type="checkbox"/>	<input type="checkbox"/>	<input type="checkbox"/>	<input type="checkbox"/>	<input type="checkbox"/>	<input type="checkbox"/>	<input type="checkbox"/>	<input type="checkbox"/>	<input type="checkbox"/>	<input type="checkbox"/>	<input type="checkbox"/>	<input type="checkbox"/>
	1360x768 @60Hz	<input type="checkbox"/>	<input type="checkbox"/>	<input type="checkbox"/>	<input type="checkbox"/>	<input type="checkbox"/>	<input type="checkbox"/>	<input type="checkbox"/>	<input type="checkbox"/>	<input type="checkbox"/>	<input type="checkbox"/>	<input type="checkbox"/>	<input type="checkbox"/>	<input type="checkbox"/>	<input type="checkbox"/>	<input type="checkbox"/>	<input type="checkbox"/>	<input type="checkbox"/>	<input type="checkbox"/>	<input type="checkbox"/>	<input type="checkbox"/>
	1366x768 @60Hz	<input type="checkbox"/>	<input type="checkbox"/>	<input type="checkbox"/>	<input type="checkbox"/>	<input type="checkbox"/>	<input type="checkbox"/>	<input type="checkbox"/>	<input type="checkbox"/>	<input type="checkbox"/>	<input type="checkbox"/>	<input type="checkbox"/>	<input type="checkbox"/>	<input type="checkbox"/>	<input type="checkbox"/>	<input type="checkbox"/>	<input type="checkbox"/>	<input type="checkbox"/>	<input type="checkbox"/>	<input type="checkbox"/>	<input type="checkbox"/>
	1600x1200 @60Hz	<input type="checkbox"/>	<input type="checkbox"/>	<input type="checkbox"/>	<input type="checkbox"/>	<input type="checkbox"/>	<input type="checkbox"/>	<input type="checkbox"/>	<input type="checkbox"/>	<input type="checkbox"/>	<input type="checkbox"/>	<input type="checkbox"/>	<input type="checkbox"/>	<input type="checkbox"/>	<input type="checkbox"/>	<input type="checkbox"/>	<input type="checkbox"/>	<input type="checkbox"/>	<input type="checkbox"/>	<input type="checkbox"/>	<input type="checkbox"/>
	1920x1080 @60Hz	<input type="checkbox"/>	<input type="checkbox"/>	<input type="checkbox"/>	<input type="checkbox"/>	<input type="checkbox"/>	<input type="checkbox"/>	<input type="checkbox"/>	<input type="checkbox"/>	<input type="checkbox"/>	<input type="checkbox"/>	<input type="checkbox"/>	<input type="checkbox"/>	<input type="checkbox"/>	<input type="checkbox"/>	<input type="checkbox"/>	<input type="checkbox"/>	<input type="checkbox"/>	<input type="checkbox"/>	<input type="checkbox"/>	<input type="checkbox"/>
	576i(50Hz)	<input type="checkbox"/>	<input type="checkbox"/>	<input type="checkbox"/>	<input type="checkbox"/>	<input type="checkbox"/>	<input type="checkbox"/>	<input type="checkbox"/>	<input type="checkbox"/>	<input type="checkbox"/>	<input type="checkbox"/>	<input type="checkbox"/>	<input type="checkbox"/>	<input type="checkbox"/>	<input type="checkbox"/>	<input type="checkbox"/>	<input type="checkbox"/>	<input type="checkbox"/>	<input type="checkbox"/>	<input type="checkbox"/>	<input type="checkbox"/>
	480i(60Hz)	<input type="checkbox"/>	<input type="checkbox"/>	<input type="checkbox"/>	<input type="checkbox"/>	<input type="checkbox"/>	<input type="checkbox"/>	<input type="checkbox"/>	<input type="checkbox"/>	<input type="checkbox"/>	<input type="checkbox"/>	<input type="checkbox"/>	<input type="checkbox"/>	<input type="checkbox"/>	<input type="checkbox"/>	<input type="checkbox"/>	<input type="checkbox"/>	<input type="checkbox"/>	<input type="checkbox"/>	<input type="checkbox"/>	<input type="checkbox"/>
	480p(60Hz)	<input type="checkbox"/>	<input type="checkbox"/>	<input type="checkbox"/>	<input type="checkbox"/>	<input type="checkbox"/>	<input type="checkbox"/>	<input type="checkbox"/>	<input type="checkbox"/>	<input type="checkbox"/>	<input type="checkbox"/>	<input type="checkbox"/>	<input type="checkbox"/>	<input type="checkbox"/>	<input type="checkbox"/>	<input type="checkbox"/>	<input type="checkbox"/>	<input type="checkbox"/>	<input type="checkbox"/>	<input type="checkbox"/>	<input type="checkbox"/>
	576p(60Hz)	<input type="checkbox"/>	<input type="checkbox"/>	<input type="checkbox"/>	<input type="checkbox"/>	<input type="checkbox"/>	<input type="checkbox"/>	<input type="checkbox"/>	<input type="checkbox"/>	<input type="checkbox"/>	<input type="checkbox"/>	<input type="checkbox"/>	<input type="checkbox"/>	<input type="checkbox"/>	<input type="checkbox"/>	<input type="checkbox"/>	<input type="checkbox"/>	<input type="checkbox"/>	<input type="checkbox"/>	<input type="checkbox"/>	<input type="checkbox"/>
	720p(50Hz)	<input type="checkbox"/>	<input type="checkbox"/>	<input type="checkbox"/>	<input type="checkbox"/>	<input type="checkbox"/>	<input type="checkbox"/>	<input type="checkbox"/>	<input type="checkbox"/>	<input type="checkbox"/>	<input type="checkbox"/>	<input type="checkbox"/>	<input type="checkbox"/>	<input type="checkbox"/>	<input type="checkbox"/>	<input type="checkbox"/>	<input type="checkbox"/>	<input type="checkbox"/>	<input type="checkbox"/>	<input type="checkbox"/>	<input type="checkbox"/>
	720p(60Hz)	<input type="checkbox"/>	<input type="checkbox"/>	<input type="checkbox"/>	<input type="checkbox"/>	<input type="checkbox"/>	<input type="checkbox"/>	<input type="checkbox"/>	<input type="checkbox"/>	<input type="checkbox"/>	<input type="checkbox"/>	<input type="checkbox"/>	<input type="checkbox"/>	<input type="checkbox"/>	<input type="checkbox"/>	<input type="checkbox"/>	<input type="checkbox"/>	<input type="checkbox"/>	<input type="checkbox"/>	<input type="checkbox"/>	<input type="checkbox"/>
1080i(50Hz)	<input type="checkbox"/>	<input type="checkbox"/>	<input type="checkbox"/>	<input type="checkbox"/>	<input type="checkbox"/>	<input type="checkbox"/>	<input type="checkbox"/>	<input type="checkbox"/>	<input type="checkbox"/>	<input type="checkbox"/>	<input type="checkbox"/>	<input type="checkbox"/>	<input type="checkbox"/>	<input type="checkbox"/>	<input type="checkbox"/>	<input type="checkbox"/>	<input type="checkbox"/>	<input type="checkbox"/>	<input type="checkbox"/>	<input type="checkbox"/>	
1080i(60Hz)	<input type="checkbox"/>	<input type="checkbox"/>	<input type="checkbox"/>	<input type="checkbox"/>	<input type="checkbox"/>	<input type="checkbox"/>	<input type="checkbox"/>	<input type="checkbox"/>	<input type="checkbox"/>	<input type="checkbox"/>	<input type="checkbox"/>	<input type="checkbox"/>	<input type="checkbox"/>	<input type="checkbox"/>	<input type="checkbox"/>	<input type="checkbox"/>	<input type="checkbox"/>	<input type="checkbox"/>	<input type="checkbox"/>	<input type="checkbox"/>	
1080p(50Hz)	<input type="checkbox"/>	<input type="checkbox"/>	<input type="checkbox"/>	<input type="checkbox"/>	<input type="checkbox"/>	<input type="checkbox"/>	<input type="checkbox"/>	<input type="checkbox"/>	<input type="checkbox"/>	<input type="checkbox"/>	<input type="checkbox"/>	<input type="checkbox"/>	<input type="checkbox"/>	<input type="checkbox"/>	<input type="checkbox"/>	<input type="checkbox"/>	<input type="checkbox"/>	<input type="checkbox"/>	<input type="checkbox"/>	<input type="checkbox"/>	
1080p(60Hz)	<input type="checkbox"/>	<input type="checkbox"/>	<input type="checkbox"/>	<input type="checkbox"/>	<input type="checkbox"/>	<input type="checkbox"/>	<input type="checkbox"/>	<input type="checkbox"/>	<input type="checkbox"/>	<input type="checkbox"/>	<input type="checkbox"/>	<input type="checkbox"/>	<input type="checkbox"/>	<input type="checkbox"/>	<input type="checkbox"/>	<input type="checkbox"/>	<input type="checkbox"/>	<input type="checkbox"/>	<input type="checkbox"/>	<input type="checkbox"/>	

		Main	DVI														
			640x480 @60Hz	640x480 @72Hz	640x480 @75Hz	720x400 @70Hz	800x600 @60Hz	800x600 @75Hz	1024x768 @60Hz	1024x768 @75Hz	1280x768 @60Hz	1280x960 @60Hz	1280x1024 @60Hz	1360x768 @60Hz	1600x1200 @60Hz	1920x1080 @60Hz	
VGA	Sub																
	640x480 @60Hz	<input type="checkbox"/>	<input type="checkbox"/>	<input type="checkbox"/>	<input type="checkbox"/>	<input type="checkbox"/>	<input type="checkbox"/>	<input type="checkbox"/>	<input type="checkbox"/>	<input type="checkbox"/>	<input type="checkbox"/>	<input type="checkbox"/>	<input type="checkbox"/>	<input type="checkbox"/>	<input type="checkbox"/>	<input type="checkbox"/>	<input type="checkbox"/>
	640x480 @72Hz	<input type="checkbox"/>	<input type="checkbox"/>	<input type="checkbox"/>	<input type="checkbox"/>	<input type="checkbox"/>	<input type="checkbox"/>	<input type="checkbox"/>	<input type="checkbox"/>	<input type="checkbox"/>	<input type="checkbox"/>	<input type="checkbox"/>	<input type="checkbox"/>	<input type="checkbox"/>	<input type="checkbox"/>	<input type="checkbox"/>	<input type="checkbox"/>
	640x480 @75Hz	<input type="checkbox"/>	<input type="checkbox"/>	<input type="checkbox"/>	<input type="checkbox"/>	<input type="checkbox"/>	<input type="checkbox"/>	<input type="checkbox"/>	<input type="checkbox"/>	<input type="checkbox"/>	<input type="checkbox"/>	<input type="checkbox"/>	<input type="checkbox"/>	<input type="checkbox"/>	<input type="checkbox"/>	<input type="checkbox"/>	<input type="checkbox"/>
	720x400 @70Hz	<input type="checkbox"/>	<input type="checkbox"/>	<input type="checkbox"/>	<input type="checkbox"/>	<input type="checkbox"/>	<input type="checkbox"/>	<input type="checkbox"/>	<input type="checkbox"/>	<input type="checkbox"/>	<input type="checkbox"/>	<input type="checkbox"/>	<input type="checkbox"/>	<input type="checkbox"/>	<input type="checkbox"/>	<input type="checkbox"/>	<input type="checkbox"/>
	800x600 @60Hz	<input type="checkbox"/>	<input type="checkbox"/>	<input type="checkbox"/>	<input type="checkbox"/>	<input type="checkbox"/>	<input type="checkbox"/>	<input type="checkbox"/>	<input type="checkbox"/>	<input type="checkbox"/>	<input type="checkbox"/>	<input type="checkbox"/>	<input type="checkbox"/>	<input type="checkbox"/>	<input type="checkbox"/>	<input type="checkbox"/>	<input type="checkbox"/>
	800x600 @75Hz	<input type="checkbox"/>	<input type="checkbox"/>	<input type="checkbox"/>	<input type="checkbox"/>	<input type="checkbox"/>	<input type="checkbox"/>	<input type="checkbox"/>	<input type="checkbox"/>	<input type="checkbox"/>	<input type="checkbox"/>	<input type="checkbox"/>	<input type="checkbox"/>	<input type="checkbox"/>	<input type="checkbox"/>	<input type="checkbox"/>	<input type="checkbox"/>
	1024x768 @60Hz	<input type="checkbox"/>	<input type="checkbox"/>	<input type="checkbox"/>	<input type="checkbox"/>	<input type="checkbox"/>	<input type="checkbox"/>	<input type="checkbox"/>	<input type="checkbox"/>	<input type="checkbox"/>	<input type="checkbox"/>	<input type="checkbox"/>	<input type="checkbox"/>	<input type="checkbox"/>	<input type="checkbox"/>	<input type="checkbox"/>	<input type="checkbox"/>
	1024x768 @75Hz	<input type="checkbox"/>	<input type="checkbox"/>	<input type="checkbox"/>	<input type="checkbox"/>	<input type="checkbox"/>	<input type="checkbox"/>	<input type="checkbox"/>	<input type="checkbox"/>	<input type="checkbox"/>	<input type="checkbox"/>	<input type="checkbox"/>	<input type="checkbox"/>	<input type="checkbox"/>	<input type="checkbox"/>	<input type="checkbox"/>	<input type="checkbox"/>
	1280x768 @60Hz	<input type="checkbox"/>	<input type="checkbox"/>	<input type="checkbox"/>	<input type="checkbox"/>	<input type="checkbox"/>	<input type="checkbox"/>	<input type="checkbox"/>	<input type="checkbox"/>	<input type="checkbox"/>	<input type="checkbox"/>	<input type="checkbox"/>	<input type="checkbox"/>	<input type="checkbox"/>	<input type="checkbox"/>	<input type="checkbox"/>	<input type="checkbox"/>
	1280x960 @60Hz	<input type="checkbox"/>	<input type="checkbox"/>	<input type="checkbox"/>	<input type="checkbox"/>	<input type="checkbox"/>	<input type="checkbox"/>	<input type="checkbox"/>	<input type="checkbox"/>	<input type="checkbox"/>	<input type="checkbox"/>	<input type="checkbox"/>	<input type="checkbox"/>	<input type="checkbox"/>	<input type="checkbox"/>	<input type="checkbox"/>	<input type="checkbox"/>
	1280x1024 @60Hz	<input type="checkbox"/>	<input type="checkbox"/>	<input type="checkbox"/>	<input type="checkbox"/>	<input type="checkbox"/>	<input type="checkbox"/>	<input type="checkbox"/>	<input type="checkbox"/>	<input type="checkbox"/>	<input type="checkbox"/>	<input type="checkbox"/>	<input type="checkbox"/>	<input type="checkbox"/>	<input type="checkbox"/>	<input type="checkbox"/>	<input type="checkbox"/>
	1360x768 @60Hz	<input type="checkbox"/>	<input type="checkbox"/>	<input type="checkbox"/>	<input type="checkbox"/>	<input type="checkbox"/>	<input type="checkbox"/>	<input type="checkbox"/>	<input type="checkbox"/>	<input type="checkbox"/>	<input type="checkbox"/>	<input type="checkbox"/>	<input type="checkbox"/>	<input type="checkbox"/>	<input type="checkbox"/>	<input type="checkbox"/>	<input type="checkbox"/>
	1366x768 @60Hz	<input type="checkbox"/>	<input type="checkbox"/>	<input type="checkbox"/>	<input type="checkbox"/>	<input type="checkbox"/>	<input type="checkbox"/>	<input type="checkbox"/>	<input type="checkbox"/>	<input type="checkbox"/>	<input type="checkbox"/>	<input type="checkbox"/>	<input type="checkbox"/>	<input type="checkbox"/>	<input type="checkbox"/>	<input type="checkbox"/>	<input type="checkbox"/>
1600x1200 @60Hz	<input type="checkbox"/>	<input type="checkbox"/>	<input type="checkbox"/>	<input type="checkbox"/>	<input type="checkbox"/>	<input type="checkbox"/>	<input type="checkbox"/>	<input type="checkbox"/>	<input type="checkbox"/>	<input type="checkbox"/>	<input type="checkbox"/>	<input type="checkbox"/>	<input type="checkbox"/>	<input type="checkbox"/>	<input type="checkbox"/>	<input type="checkbox"/>	
1920x1080 @60Hz	<input type="checkbox"/>	<input type="checkbox"/>	<input type="checkbox"/>	<input type="checkbox"/>	<input type="checkbox"/>	<input type="checkbox"/>	<input type="checkbox"/>	<input type="checkbox"/>	<input type="checkbox"/>	<input type="checkbox"/>	<input type="checkbox"/>	<input type="checkbox"/>	<input type="checkbox"/>	<input type="checkbox"/>	<input type="checkbox"/>	<input type="checkbox"/>	

		Main	DVI													
			640x480 @60Hz	640x480 @72Hz	640x480 @75Hz	720x400 @70Hz	800x600 @60Hz	800x600 @75Hz	1024x768 @60Hz	1024x768 @75Hz	1280x768 @60Hz	1280x960 @60Hz	1280x1024 @60Hz	1360x768 @60Hz	1600x1200 @60Hz	1920x1080 @60Hz
YPbPr	Sub															
	576i(50Hz)	<input type="checkbox"/>	<input type="checkbox"/>	<input type="checkbox"/>	<input type="checkbox"/>	<input type="checkbox"/>	<input type="checkbox"/>	<input type="checkbox"/>	<input type="checkbox"/>	<input type="checkbox"/>	<input type="checkbox"/>	<input type="checkbox"/>	<input type="checkbox"/>	<input type="checkbox"/>	<input type="checkbox"/>	<input type="checkbox"/>
	480i(60Hz)	<input type="checkbox"/>	<input type="checkbox"/>	<input type="checkbox"/>	<input type="checkbox"/>	<input type="checkbox"/>	<input type="checkbox"/>	<input type="checkbox"/>	<input type="checkbox"/>	<input type="checkbox"/>	<input type="checkbox"/>	<input type="checkbox"/>	<input type="checkbox"/>	<input type="checkbox"/>	<input type="checkbox"/>	<input type="checkbox"/>
	480p(60Hz)	<input type="checkbox"/>	<input type="checkbox"/>	<input type="checkbox"/>	<input type="checkbox"/>	<input type="checkbox"/>	<input type="checkbox"/>	<input type="checkbox"/>	<input type="checkbox"/>	<input type="checkbox"/>	<input type="checkbox"/>	<input type="checkbox"/>	<input type="checkbox"/>	<input type="checkbox"/>	<input type="checkbox"/>	<input type="checkbox"/>
	576p(60Hz)	<input type="checkbox"/>	<input type="checkbox"/>	<input type="checkbox"/>	<input type="checkbox"/>	<input type="checkbox"/>	<input type="checkbox"/>	<input type="checkbox"/>	<input type="checkbox"/>	<input type="checkbox"/>	<input type="checkbox"/>	<input type="checkbox"/>	<input type="checkbox"/>	<input type="checkbox"/>	<input type="checkbox"/>	<input type="checkbox"/>
	720p(50Hz)	<input type="checkbox"/>	<input type="checkbox"/>	<input type="checkbox"/>	<input type="checkbox"/>	<input type="checkbox"/>	<input type="checkbox"/>	<input type="checkbox"/>	<input type="checkbox"/>	<input type="checkbox"/>	<input type="checkbox"/>	<input type="checkbox"/>	<input type="checkbox"/>	<input type="checkbox"/>	<input type="checkbox"/>	<input type="checkbox"/>
	720p(60Hz)	<input type="checkbox"/>	<input type="checkbox"/>	<input type="checkbox"/>	<input type="checkbox"/>	<input type="checkbox"/>	<input type="checkbox"/>	<input type="checkbox"/>	<input type="checkbox"/>	<input type="checkbox"/>	<input type="checkbox"/>	<input type="checkbox"/>	<input type="checkbox"/>	<input type="checkbox"/>	<input type="checkbox"/>	<input type="checkbox"/>
	1080i(50Hz)	<input type="checkbox"/>	<input type="checkbox"/>	<input type="checkbox"/>	<input type="checkbox"/>	<input type="checkbox"/>	<input type="checkbox"/>	<input type="checkbox"/>	<input type="checkbox"/>	<input type="checkbox"/>	<input type="checkbox"/>	<input type="checkbox"/>	<input type="checkbox"/>	<input type="checkbox"/>	<input type="checkbox"/>	<input type="checkbox"/>
	1080i(60Hz)	<input type="checkbox"/>	<input type="checkbox"/>	<input type="checkbox"/>	<input type="checkbox"/>	<input type="checkbox"/>	<input type="checkbox"/>	<input type="checkbox"/>	<input type="checkbox"/>	<input type="checkbox"/>	<input type="checkbox"/>	<input type="checkbox"/>	<input type="checkbox"/>	<input type="checkbox"/>	<input type="checkbox"/>	<input type="checkbox"/>
	1080p(50Hz)	<input type="checkbox"/>	<input type="checkbox"/>	<input type="checkbox"/>	<input type="checkbox"/>	<input type="checkbox"/>	<input type="checkbox"/>	<input type="checkbox"/>	<input type="checkbox"/>	<input type="checkbox"/>	<input type="checkbox"/>	<input type="checkbox"/>	<input type="checkbox"/>	<input type="checkbox"/>	<input type="checkbox"/>	<input type="checkbox"/>
1080p(60Hz)	<input type="checkbox"/>	<input type="checkbox"/>	<input type="checkbox"/>	<input type="checkbox"/>	<input type="checkbox"/>	<input type="checkbox"/>	<input type="checkbox"/>	<input type="checkbox"/>	<input type="checkbox"/>	<input type="checkbox"/>	<input type="checkbox"/>	<input type="checkbox"/>	<input type="checkbox"/>	<input type="checkbox"/>	<input type="checkbox"/>	

		Main	HDMI														
			640x480 @60Hz	640x480 @72Hz	640x480 @75Hz	720x400 @70Hz	800x600 @60Hz	800x600 @75Hz	1024x768 @60Hz	1024x768 @75Hz	1280x768 @60Hz	1280x960 @60Hz	1280x1024 @60Hz	1360x768 @60Hz	1600x1200 @60Hz	1920x1080 @60Hz	
Sub	VGA	640x480 @60Hz	○	○	○	○	○	○	○	○	○	○	○	○	○	○	○
		640x480 @72Hz	○	○	○	○	○	○	○	○	○	○	○	○	○	○	○
		640x480 @75Hz	○	○	○	○	○	○	○	○	○	○	○	○	○	○	○
		720x400 @70Hz	○	○	○	○	○	○	○	○	○	○	○	○	○	○	○
		800x600 @60Hz	○	○	○	○	○	○	○	○	○	○	○	○	○	○	○
		800x600 @75Hz	○	○	○	○	○	○	○	○	○	○	○	○	○	○	○
		1024x768 @60Hz	○	○	○	○	○	○	○	○	○	○	○	○	○	○	○
		1024x768 @75Hz	○	○	○	○	○	○	○	○	○	○	○	○	○	○	○
		1280x768 @60Hz	○	○	○	○	○	○	○	○	○	○	○	○	○	○	○
		1280x960 @60Hz	○	○	○	○	○	○	○	○	○	○	○	○	○	○	○
		1280x1024 @60Hz	○	○	○	○	○	○	○	○	○	○	○	○	○	○	○
		1360x768 @60Hz	○	○	○	○	○	○	○	○	○	○	○	○	○	○	○
		1366x768 @60Hz	○	○	○	○	○	○	○	○	○	○	○	○	○	○	○
		1600x1200 @60Hz	○	○	○	○	○	○	○	○	○	○	○	○	○	○	○
1920x1080 @60Hz	○	○	○	○	○	○	○	○	○	○	○	○	○	○	○		

		Main	HDMI											
			576i(50Hz)	480i(60Hz)	480p(60Hz)	576p(60Hz)	720p(50Hz)	720p(60Hz)	1080i(50Hz)	1080i(60Hz)	1080p(50Hz)	1080p(60Hz)		
Sub	VGA	640x480 @60Hz	○	○	○	○	○	○	○	○	○	○	○	○
		640x480 @72Hz	○	○	○	○	○	○	○	○	○	○	○	○
		640x480 @75Hz	○	○	○	○	○	○	○	○	○	○	○	○
		720x400 @70Hz	○	○	○	○	○	○	○	○	○	○	○	○
		800x600 @60Hz	○	○	○	○	○	○	○	○	○	○	○	○
		800x600 @75Hz	○	○	○	○	○	○	○	○	○	○	○	○
		1024x768 @60Hz	○	○	○	○	○	○	○	○	○	○	○	○
		1024x768 @75Hz	○	○	○	○	○	○	○	○	○	○	○	○
		1280x768 @60Hz	○	○	○	○	○	○	○	○	○	○	○	○
		1280x960 @60Hz	○	○	○	○	○	○	○	○	○	○	○	○
		1280x1024 @60Hz	○	○	○	○	○	○	○	○	○	○	○	○
		1360x768 @60Hz	○	○	○	○	○	○	○	○	○	○	○	○
		1366x768 @60Hz	○	○	○	○	○	○	○	○	○	○	○	○
		1600x1200 @60Hz	○	○	○	○	○	○	○	○	○	○	○	○
1920x1080 @60Hz	○	○	○	○	○	○	○	○	○	○	○	○		

		Main	HDMI									
			576i(50Hz)	480i(60Hz)	480p(60Hz)	576p(60Hz)	720p(50Hz)	720p(60Hz)	1080i(50Hz)	1080i(60Hz)	1080p(50Hz)	1080p(60Hz)
YPbPr	576i(50Hz)	<input type="checkbox"/>	<input type="checkbox"/>	<input type="checkbox"/>	<input type="checkbox"/>	<input type="checkbox"/>	<input type="checkbox"/>	<input type="checkbox"/>	<input type="checkbox"/>	<input type="checkbox"/>	<input type="checkbox"/>	<input type="checkbox"/>
	480i(60Hz)	<input type="checkbox"/>	<input type="checkbox"/>	<input type="checkbox"/>	<input type="checkbox"/>	<input type="checkbox"/>	<input type="checkbox"/>	<input type="checkbox"/>	<input type="checkbox"/>	<input type="checkbox"/>	<input type="checkbox"/>	<input type="checkbox"/>
	480p(60Hz)	<input type="checkbox"/>	<input type="checkbox"/>	<input type="checkbox"/>	<input type="checkbox"/>	<input type="checkbox"/>	<input type="checkbox"/>	<input type="checkbox"/>	<input type="checkbox"/>	<input type="checkbox"/>	<input type="checkbox"/>	<input type="checkbox"/>
	576p(60Hz)	<input type="checkbox"/>	<input type="checkbox"/>	<input type="checkbox"/>	<input type="checkbox"/>	<input type="checkbox"/>	<input type="checkbox"/>	<input type="checkbox"/>	<input type="checkbox"/>	<input type="checkbox"/>	<input type="checkbox"/>	<input type="checkbox"/>
	720p(50Hz)	<input type="checkbox"/>	<input type="checkbox"/>	<input type="checkbox"/>	<input type="checkbox"/>	<input type="checkbox"/>	<input type="checkbox"/>	<input type="checkbox"/>	<input type="checkbox"/>	<input type="checkbox"/>	<input type="checkbox"/>	<input type="checkbox"/>
	720p(60Hz)	<input type="checkbox"/>	<input type="checkbox"/>	<input type="checkbox"/>	<input type="checkbox"/>	<input type="checkbox"/>	<input type="checkbox"/>	<input type="checkbox"/>	<input type="checkbox"/>	<input type="checkbox"/>	<input type="checkbox"/>	<input type="checkbox"/>
	1080i(50Hz)	<input type="checkbox"/>	<input type="checkbox"/>	<input type="checkbox"/>	<input type="checkbox"/>	<input type="checkbox"/>	<input type="checkbox"/>	<input type="checkbox"/>	<input type="checkbox"/>	<input type="checkbox"/>	<input type="checkbox"/>	<input type="checkbox"/>
	1080i(60Hz)	<input type="checkbox"/>	<input type="checkbox"/>	<input type="checkbox"/>	<input type="checkbox"/>	<input type="checkbox"/>	<input type="checkbox"/>	<input type="checkbox"/>	<input type="checkbox"/>	<input type="checkbox"/>	<input type="checkbox"/>	<input type="checkbox"/>
	1080p(50Hz)	<input type="checkbox"/>	<input type="checkbox"/>	<input type="checkbox"/>	<input type="checkbox"/>	<input type="checkbox"/>	<input type="checkbox"/>	<input type="checkbox"/>	<input type="checkbox"/>	<input type="checkbox"/>	<input type="checkbox"/>	<input type="checkbox"/>
1080p(60Hz)	<input type="checkbox"/>	<input type="checkbox"/>	<input type="checkbox"/>	<input type="checkbox"/>	<input type="checkbox"/>	<input type="checkbox"/>	<input type="checkbox"/>	<input type="checkbox"/>	<input type="checkbox"/>	<input type="checkbox"/>	<input type="checkbox"/>	

		Main	YPbPr									
			576i(50Hz)	480i(60Hz)	480p(60Hz)	576p(60Hz)	720p(50Hz)	720p(60Hz)	1080i(50Hz)	1080i(60Hz)	1080p(50Hz)	1080p(60Hz)
DVI	640x480 @60Hz	<input type="checkbox"/>	<input type="checkbox"/>	<input type="checkbox"/>	<input type="checkbox"/>	<input type="checkbox"/>	<input type="checkbox"/>	<input type="checkbox"/>	<input type="checkbox"/>	<input type="checkbox"/>	<input type="checkbox"/>	<input type="checkbox"/>
	640x480 @72Hz	<input type="checkbox"/>	<input type="checkbox"/>	<input type="checkbox"/>	<input type="checkbox"/>	<input type="checkbox"/>	<input type="checkbox"/>	<input type="checkbox"/>	<input type="checkbox"/>	<input type="checkbox"/>	<input type="checkbox"/>	<input type="checkbox"/>
	640x480 @75Hz	<input type="checkbox"/>	<input type="checkbox"/>	<input type="checkbox"/>	<input type="checkbox"/>	<input type="checkbox"/>	<input type="checkbox"/>	<input type="checkbox"/>	<input type="checkbox"/>	<input type="checkbox"/>	<input type="checkbox"/>	<input type="checkbox"/>
	720x400 @70Hz	<input type="checkbox"/>	<input type="checkbox"/>	<input type="checkbox"/>	<input type="checkbox"/>	<input type="checkbox"/>	<input type="checkbox"/>	<input type="checkbox"/>	<input type="checkbox"/>	<input type="checkbox"/>	<input type="checkbox"/>	<input type="checkbox"/>
	800x600 @60Hz	<input type="checkbox"/>	<input type="checkbox"/>	<input type="checkbox"/>	<input type="checkbox"/>	<input type="checkbox"/>	<input type="checkbox"/>	<input type="checkbox"/>	<input type="checkbox"/>	<input type="checkbox"/>	<input type="checkbox"/>	<input type="checkbox"/>
	800x600 @75Hz	<input type="checkbox"/>	<input type="checkbox"/>	<input type="checkbox"/>	<input type="checkbox"/>	<input type="checkbox"/>	<input type="checkbox"/>	<input type="checkbox"/>	<input type="checkbox"/>	<input type="checkbox"/>	<input type="checkbox"/>	<input type="checkbox"/>
	1024x768 @60Hz	<input type="checkbox"/>	<input type="checkbox"/>	<input type="checkbox"/>	<input type="checkbox"/>	<input type="checkbox"/>	<input type="checkbox"/>	<input type="checkbox"/>	<input type="checkbox"/>	<input type="checkbox"/>	<input type="checkbox"/>	<input type="checkbox"/>
	1024x768 @75Hz	<input type="checkbox"/>	<input type="checkbox"/>	<input type="checkbox"/>	<input type="checkbox"/>	<input type="checkbox"/>	<input type="checkbox"/>	<input type="checkbox"/>	<input type="checkbox"/>	<input type="checkbox"/>	<input type="checkbox"/>	<input type="checkbox"/>
	1280x768 @60Hz	<input type="checkbox"/>	<input type="checkbox"/>	<input type="checkbox"/>	<input type="checkbox"/>	<input type="checkbox"/>	<input type="checkbox"/>	<input type="checkbox"/>	<input type="checkbox"/>	<input type="checkbox"/>	<input type="checkbox"/>	<input type="checkbox"/>
	1280x960 @60Hz	<input type="checkbox"/>	<input type="checkbox"/>	<input type="checkbox"/>	<input type="checkbox"/>	<input type="checkbox"/>	<input type="checkbox"/>	<input type="checkbox"/>	<input type="checkbox"/>	<input type="checkbox"/>	<input type="checkbox"/>	<input type="checkbox"/>
	1280x1024 @60Hz	<input type="checkbox"/>	<input type="checkbox"/>	<input type="checkbox"/>	<input type="checkbox"/>	<input type="checkbox"/>	<input type="checkbox"/>	<input type="checkbox"/>	<input type="checkbox"/>	<input type="checkbox"/>	<input type="checkbox"/>	<input type="checkbox"/>
	1360x768 @60Hz	<input type="checkbox"/>	<input type="checkbox"/>	<input type="checkbox"/>	<input type="checkbox"/>	<input type="checkbox"/>	<input type="checkbox"/>	<input type="checkbox"/>	<input type="checkbox"/>	<input type="checkbox"/>	<input type="checkbox"/>	<input type="checkbox"/>
	1366x768 @60Hz	<input type="checkbox"/>	<input type="checkbox"/>	<input type="checkbox"/>	<input type="checkbox"/>	<input type="checkbox"/>	<input type="checkbox"/>	<input type="checkbox"/>	<input type="checkbox"/>	<input type="checkbox"/>	<input type="checkbox"/>	<input type="checkbox"/>
1600x1200 @60Hz	<input type="checkbox"/>	<input type="checkbox"/>	<input type="checkbox"/>	<input type="checkbox"/>	<input type="checkbox"/>	<input type="checkbox"/>	<input type="checkbox"/>	<input type="checkbox"/>	<input type="checkbox"/>	<input type="checkbox"/>	<input type="checkbox"/>	
1920x1080 @60Hz	<input type="checkbox"/>	<input type="checkbox"/>	<input type="checkbox"/>	<input type="checkbox"/>	<input type="checkbox"/>	<input type="checkbox"/>	<input type="checkbox"/>	<input type="checkbox"/>	<input type="checkbox"/>	<input type="checkbox"/>	<input type="checkbox"/>	